



Modified : May - 2026



CRYSTAL INTERIOR PRODUCTS PVT. LTD.
 (CIN.U93090GJ2006PTC048545)

Address : Plot No. 41, Ichhapore GIDC, Opp. ONGC, Sachin-Hazira Road,
 Bhatpore Village, Surat - 394510 (Gujarat) INDIA
 Phone : +91 9879642266, 9879652266
 Email : info@oliveworld.co.in Web : www.oliveworld.co.in

ALSO FOLLOW US ON



Olive Catalogue



Website



Instagram



OLIVENDIAOFFICIAL



PRODUCT CATALOGUE - 2026
 KITCHEN ACCESSORIES • HARDWARE FITTINGS • WARDROBE ACCESSORIES



About us

With a legacy of 25 years, Crystal Interior Products Pvt. Ltd. (Olive) stands as an industry leader in crafting innovative Modular Kitchen Solutions and Wardrobe Accessories.

Our company stands tall with a workforce exceeding 1500+ dedicated employees. Our diverse portfolio encompasses over 190+ products, and we take pride in our mastery of crafting Kitchen Storage Solutions, Kitchen Accessories, Kitchen Hardware Fittings, Wardrobe Accessories, Bathroom Accessories.

As a testament to our commitment to quality, we are proud holders of the ISO 9001:2015 certification. Over the past quarter-century, our unwavering dedication to excellence, coupled with the ever-growing demand for our products, has solidified our position as a distinguished brand under the renowned name "Olive". The consistent support and goodwill of our customers have established us as one of the most sought-after brands in the industry.

We are committed to staying at the forefront of innovation. Our dedicated research and development team continuously explores new materials, technologies, and design concepts to bring the latest trends and functionalities to our products.

All products are factory made from best quality grade, enhances the glamour and durability of the products. Each element is meticulously designed after extensive R & D work. All the operations of manufacturing process are carried out under strict supervision. All units come in a knock down condition for quick installation as per approval designed requirement and can be added in parts or can be expanded as the need arises.

Currently, Olive is represented by more than 50 Distributors & 5000+ Dealers across India. Each Dealer & Distributor has full range of our products to ensure the timely supply of the required products. So now if you plan on becoming chic and classy it is time to welcome an all new era in household accessories with "OLIVE" stainless steel utilities and let your kitchen compliment the elegance of your living room.

Finally and above all, constant increase in demand and goodwill of the customers since 25 years is itself and undeniable proof of the highest quality.



CONTENT

- 05 SLIMCA DRAWERS
- 20 SLIMTEK DRAWERS
- 24 DRAWELL BOX
- 28 SMARTEK GLASS DRAWERS
- 32 PRIME SERIES
- 35 PLATINUM SERIES
- 39 KITCHEN PULLOUTS
- 41 SMART ORGANIZERS
- 51 MIDWAY UNIT
- 55 JAR ORGANIZERS
- 59 CORNER UNITS
- 61 TANDEM PANTRY UNITS
- 64 ROLLING SHUTTERS
- 69 WICKER BASKETS

WELCOME TO THE WORLD OF OLIVE

- 75 WARDROBE ACCESSORIES
- 104 SLIDING DOOR SYSTEM
- 108 KITCHEN SOLUTION
- 113 HARDWARE FITTINGS
- 119 AUTO HINGES

*The New
Look of Home*



Slimca H-94mm

Standard Drawer



Specification

- > Standard drawer to accommodate cutlery & low height utensils.
- > 8mm side panels made of high quality metal & high class finish.
- > Weight capacity 40kgs for 12 to 22 inches.
- > Weight capacity 60kgs for 20 & 22 inches.

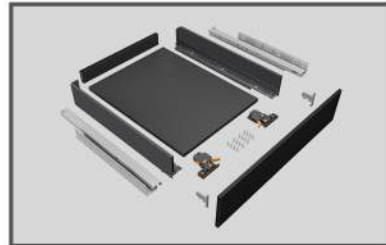

Finish	Available in depth (inch)					
Grey	12	14	16	18	20	22
White				18	20	22
Beige				18	20	22
Mocha				18	20	22
Light Wooden				18	20	

Slimca H-152mm

Standard Drawer



Specification

- > Slim intermediate height for medium size utensils, groceries and storage.
- > 8mm side panels made of high quality metal & high class finish.
- > Weight capacity 40kgs for 12 to 22 inches.
- > Weight capacity 60kgs for 20 & 22 inches.

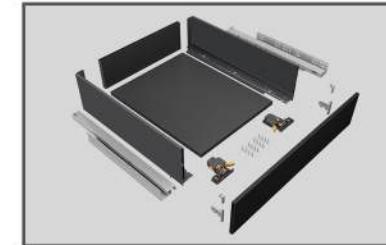

Finish	Available in depth (inch)					
Grey	12	14	16	18	20	22
White				18	20	22
Beige				18	20	22
Mocha				18	20	22
Light Wooden				18	20	

Slimca H-122mm

Standard Drawer

INSTALLATION VIDEO



Specification

- > Standard drawer to accommodate cup saucer, dishes & low height utensils.
- > 8mm side panels made of high quality metal & high class finish.
- > Weight capacity 40kgs for 12 to 22 inches.
- > Weight capacity 60kgs for 20 & 22 inches.

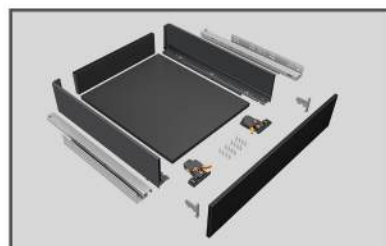

Finish	Available in depth (inch)					
Grey	12	14	16	18	20	22
White				18	20	22
Beige				18	20	22
Mocha				18	20	22
Light Wooden				18	20	

*Note: Actual finish may vary from the images shown.

Slimca H-202mm

Standard Drawer

INSTALLATION VIDEO



Specification

- > Slim & high closed sides drawer for thali-plate, heightened containers and storage.
- > 8mm side panels made of high quality metal & high class finish.
- > Weight capacity 40kgs for 12 to 22 inches.
- > Weight capacity 60kgs for 20 & 22 inches.

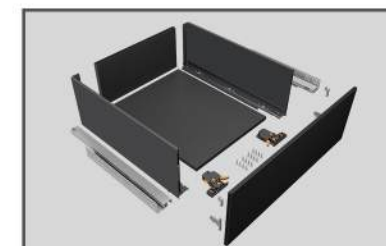

Finish	Available in depth (inch)					
Grey	12	14	16	18	20	22
White				18	20	22
Beige				18	20	22
Mocha				18	20	22
Light Wooden				18	20	

*Note: Actual finish may vary from the images shown.

Slimca H-252mm

Standard Drawer



Specification

- > Slim & very high closed sides drawer for large utensils, large containers etc.
- > 8mm side panels made of high quality metal & high class finish.
- > Weight capacity 40kgs for 18, 20 & 22 inches.
- > Weight capacity 60kgs for 20 & 22 inches.

SOFT
CLOSE

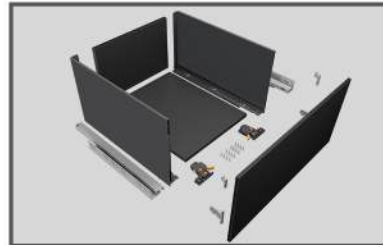

Finish	Depths Sizes in Inches		
Grey	18	20	22
White	18	20	22
Beige	18	20	22
Mocha	18	20	22
Light Wooden	18	20	

Slimca H-152mm

Glass Drawer [Toughened Glass]



Specification

- > 2 side glass for an elegant look, convenient storage of medium heighted containers.
- > Combination of high quality metal panels with glass
- > Weight capacity 40kgs for 18, 20 & 22 inches.
- > Weight capacity 60kgs for 20 & 22 inches.

SOFT
CLOSE

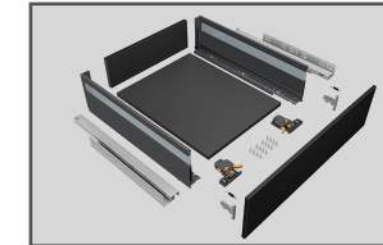

Finish	Depths Sizes in Inches		
Grey	18	20	22
White	18	20	
Beige	18	20	
Mocha	18	20	

Slimca H-292mm

Standard Drawer

INSTALLATION
VIDEO



Specification

- > Slim & very high closed sides for pan, chopping board, lid & extra large utensils.
- > 8mm side panels made of high quality metal & high class finish.
- > Weight capacity 40kgs for 18, 20 & 22 inches.
- > Weight capacity 60kgs for 20 & 22 inches.

SOFT
CLOSE

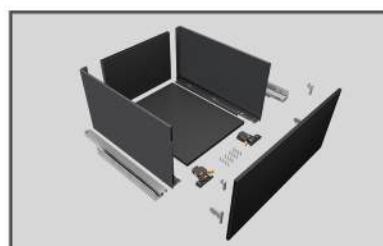

Finish	Depths Sizes in Inches		
Grey	18	20	22
White	18	20	22
Beige	18	20	22
Mocha	18	20	22
Light Wooden	18	20	

*Note: Actual finish may vary from the images shown.

Slimca H-202mm

Glass Drawer [Toughened Glass]

INSTALLATION
VIDEO



Specification

- > 2 side glass for an elegant look, convenient storage of medium heighted containers.
- > Combination of high quality metal panels with glass
- > Weight capacity 40kgs for 18, 20 & 22 inches.
- > Weight capacity 60kgs for 20 & 22 inches.

SOFT
CLOSE



Finish	Depths Sizes in Inches		
Grey	18	20	22
White	18	20	
Beige	18	20	
Mocha	18	20	

*Note: Actual finish may vary from the images shown.

Slimca - Front Panel IN H-94mm

For Standard Drawer



Specification

- > Front panel IN S-94mm for standard drawer depth 12, 14, 16, 18, 20 & 22 inches.
- > Inner drawer to accommodate cutlery & low height utensils.
- > World's slimmest 8mm drawer design with high degree of stability.

SOFT
CLOSE

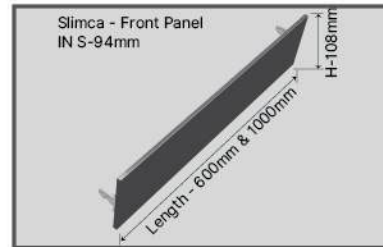

Finish	Depth Sizes in Inches					
Grey	12	14	16	18	20	22
White	12	14	16	18	20	22
Beige	12	14	16	18	20	22
Mocha	12	14	16	18	20	22

Slimca - Front Panel IN H-152mm

For Standard Drawer



Specification

- > Front panel IN S-152mm for standard drawer depth 12, 14, 16, 18, 20 & 22 inches.
- > Inner drawer to accommodate medium size utensils, groceries and storage.
- > World's slimmest 8mm drawer design with high degree of stability.

SOFT
CLOSE

INSTALLATION
VIDEO

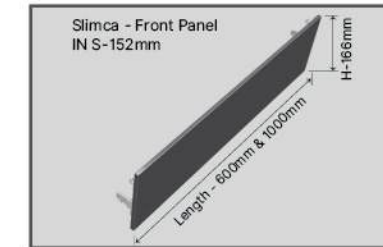

Finish	Depth Sizes in Inches		
Grey	18	20	22
White	18	20	
Beige	18	20	
Mocha	18	20	

Slimca - Front Panel IN H-122mm

For Standard Drawer

INSTALLATION
VIDEO



Specification

- > Front panel IN S-122mm for standard drawer depth 12, 14, 16, 18, 20 & 22 inches.
- > Inner drawer to accommodate cup saucer, plates & low height utensils.
- > World's slimmest 8mm drawer design with high degree of stability.

SOFT
CLOSE

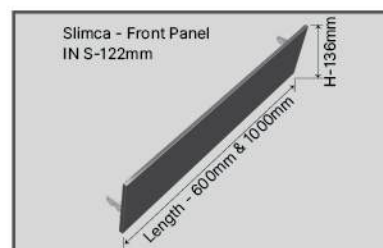

Finish	Depth Sizes in Inches					
Grey	12	14	16	18	20	22
White	12	14	16	18	20	22
Beige	12	14	16	18	20	22
Mocha	12	14	16	18	20	22

*Note: Actual finish may vary from the images shown.

Slimca - Glass Front Panel IN 3G-152mm

For Glass Standard Inner Drawer

INSTALLATION
VIDEO



Specification

- > Glass front panel IN 3G-152mm for glass drawer depth 18, 20 & 22 inches.
- > Combination of high quality metal panel with glass.
- > World's slimmest 8mm drawer design with high degree of stability.

SOFT
CLOSE

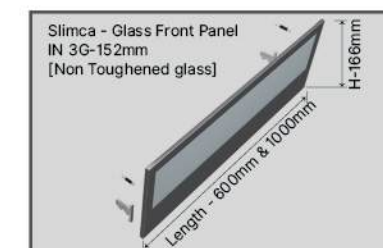

Finish	Depth Sizes in Inches		
Grey	18	20	22
White	18	20	22
Beige	18	20	22
Mocha	18	20	22

*Note: Actual finish may vary from the images shown.

Slimca - Glass Front Panel IN 3G-202mm

For Glass Standard Inner Drawer



INSTALLATION VIDEO



SOFT CLOSE

Specification

- > Glass front panel IN 3G-202 for glass drawer depth 18, 20 & 22 inches.
- > Combination of high quality metal panel with glass.
- > World's slimmest 8mm drawer design with high degree of stability.

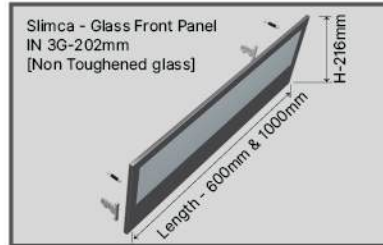

Finish	Depth Sizes in Inches				
Grey	18	20	22		
White	18	20	22		
Beige	18	20	22		
Mocha	18	20	22		

Slimca - Glass Front Panel IN 1G-152mm

For Standard Inner Drawer



SOFT CLOSE

Specification

- > Glass front panel IN 1G-152mm for standard drawer depth 12, 14, 16, 18, 20 & 22 inches.
- > Combination of high quality metal panel with glass.
- > World's slimmest 8mm drawer design with high degree of stability.

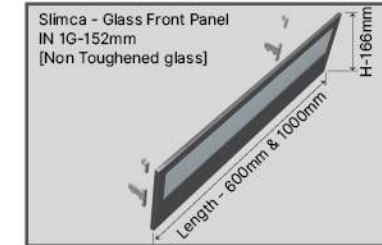

Finish	Depth Sizes in Inches					
Grey	12	14	16	18	20	22
White	12	14	16	18	20	22
Beige	12	14	16	18	20	22
Mocha	12	14	16	18	20	22

Slimca - Glass Front Panel IN 1G-94mm

For Standard Inner Drawer

INSTALLATION VIDEO



SOFT CLOSE

Specification

- > Glass front panel IN 1G-94mm for standard drawer depth 12, 14, 16, 18, 20 & 22 inches.
- > Combination of high quality metal panel with glass.
- > World's slimmest 8mm drawer design with high degree of stability.

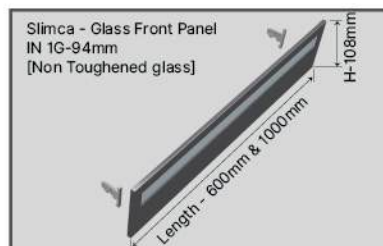

Finish	Depth Sizes in Inches					
Grey	12	14	16	18	20	22
White	12	14	16	18	20	22
Beige	12	14	16	18	20	22
Mocha	12	14	16	18	20	22

*Note: Actual finish may vary from the images shown.

Slimca - Glass Front Panel IN 1G-202mm

For Standard Inner Drawer

INSTALLATION VIDEO



SOFT CLOSE

Specification

- > Glass front panel IN 1G-202mm for standard drawer depth 12, 14, 16, 18, 20 & 22 inches.
- > Combination of high quality metal panel with glass.
- > World's slimmest 8mm drawer design with high degree of stability.

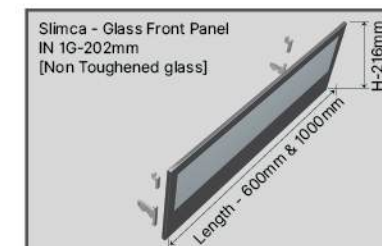

Finish	Depth Sizes in Inches					
Grey	12	14	16	18	20	22
White	12	14	16	18	20	22
Beige	12	14	16	18	20	22
Mocha	12	14	16	18	20	22

*Note: Actual finish may vary from the images shown.

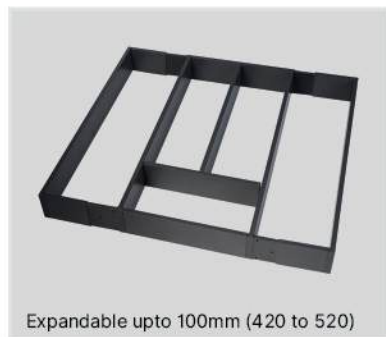
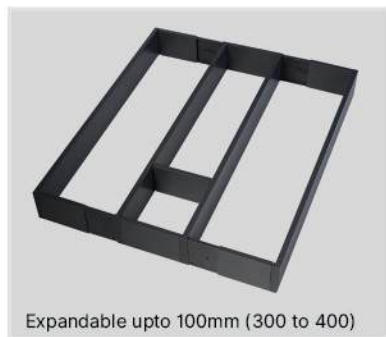

Specification

- › Cutlery organizer tray.
- › Systematic storage for cutlery.
- › Sizes : W-300 to 400 x D-425, 475, 525 x H-60mm
- › Sizes : W-420 to 520 x D-425, 475, 525 x H-60mm
- › Available in Grey & Beige Finishes.

Carcass Size 400 & 450mm

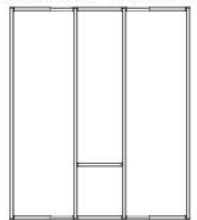

W-300-400 x D-425, 475, 525
H-60 - 1 Pcs.

Carcass Size 500 & 550mm

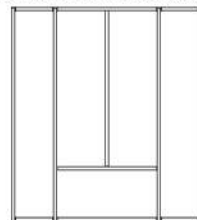

W-420-520 x D-425, 475, 525
H-60 - 1 Pcs.

Carcass Size 600mm

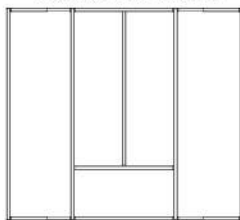

W-420-520 x D-425, 475, 525
H-60 - 1 Pcs.

Carcass Size 700 & 750mm

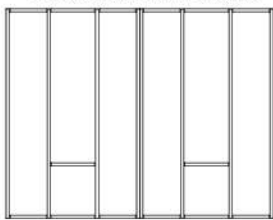

W-300-400 x D-425, 475, 525
H-60 - 2 Pcs.

Carcass Size 800 & 850mm

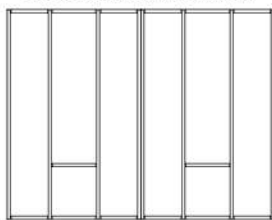

W-300-400 x D-425, 475, 525 x H-60 - 2 Pcs.

Carcass Size 900 & 950mm



W-300-400 x D-425, 475, 525 x H-60 - 1 Pcs.
W-420-520 x D-425, 475, 525 x H-60 - 1 Pcs.

Carcass Size 1000mm

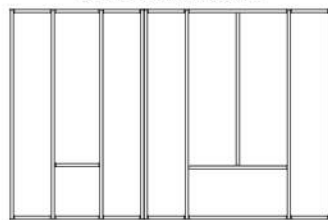

W-300-400 x D-425, 475, 525 x H-60 - 1 Pcs.
W-420-520 x D-425, 475, 525 x H-60 - 1 Pcs.



Spoon Rack

- › Individual, stacked compartments for different cutlery.
- › Systematic storage of your spoon, butter knives and fork.
- › Size : W-115mm x D-425, 475, 525mm x H-70mm



Spice Bottle Rack

- › Individual compartments for different spices bottles.
- › Spice bottle rack are easy to wash & dries quickly.
- › Bottles included with the tray.
- › Size : W-115mm x D-425, 475, 525mm x H-90mm



Spice Bottle Tray

- › Individual compartments for different spices bottles.
- › Easy to handle & can store all spices in one tray.
- › Bottles included with the tray.
- › Size : W-125mm x D-270mm x H-95mm





Slimline Box 1

- › Slimca accessories harmonises elegantly with our slimca drawer.
- › It has clean & slim lines, The box is loose and moveable which makes it more convenient for storage.
- › Size : W-190mm x D-475, 525mm x H-118mm



Slimline Box 2

- › A slim & elegant dividing system which beautifully organises & compliments your kitchen drawer.
- › It has two loose and moveable boxes which makes it more convenient for storage
- › Size : W-190mm x D-475, 525mm x H-118mm



Pan Holder

- › A firm and elegant design that comes with 7 divider to organise your pan.
- › Break free from balancing tower of pans & scratching of non stick coatings.
- › Size : W-270mm x D-475, 525mm x H-70mm



Chopping Board Vertical

- › Slim divider organizer that stores chopping boards and other heightened utensils conveniently.
- › It compliments with any heightened drawer and can be placed as per convenience
- › Size : W-190mm x D-475, 525mm x H-118mm



Chopping Board Horizontal

- › This beautiful organizer is perfect for storage of your chopping & cutting boards. Its sturdy design prevents it from toppling over.
- › Keep your everyday cutting boards upright and secure.
- › Size : W-Upto 1000mm x D-50mm x H-170 to 290mm



Lid Holder

- › A stylish organized storage solution for pan lids.
- › It is perfect for mounting on cupboard doors and inside deep drawers, organise lids with ease.
- › Size : W-310, 510mm x D-50mm x H-50mm





Saucer Holder
W-80mm x D-425, 475, 525mm x H-100mm



Plate Holder
W-120mm x D-425, 475, 525mm x H-150mm



Hanging Rack
W-340mm, 440mm x D-130 x H-140mm



Multipurpose Tray D-1
W-180mm x D-300mm x H-130mm



Multipurpose Tray D-2
W-130mm x D-300mm x H-140mm



Multipurpose Tray D-3
W-150mm x D-475, 525mm x H-100mm

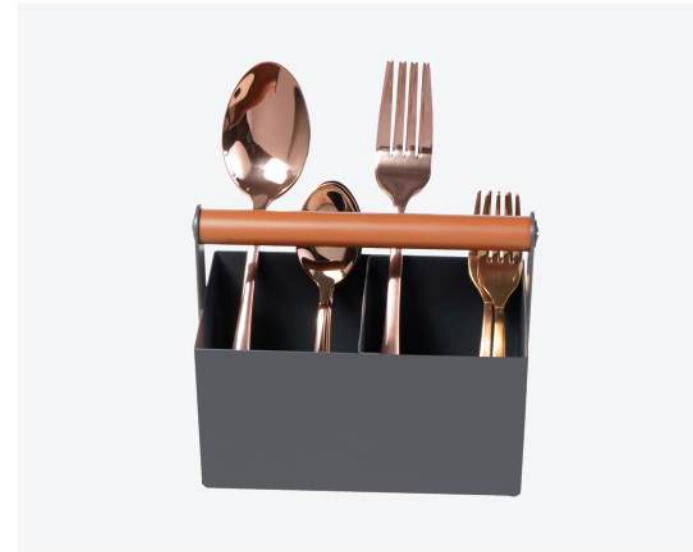

Cutlery Holder D-1
W-85mm x D-150mm x H-130mm



Cutlery Holder D-2
W-85mm x D-300mm x H-130mm



Cutlery Holder D-3
W-150mm x D-300mm x H-130mm

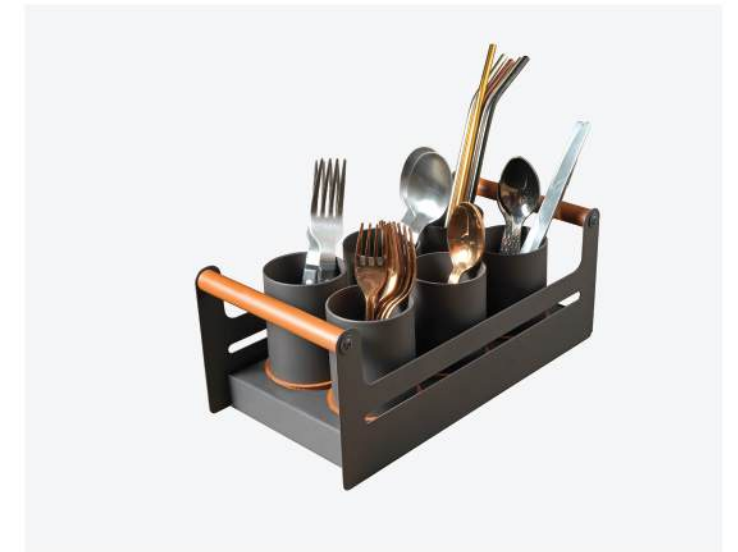

Cutlery Holder D-4
W-150mm x D-300mm x H-130mm



Serving Tray
W-250mm x D-480mm x H-60mm



Pot & Pan Hanger
W-100mm x D-505mm x H-120mm



Finish - Grey



Finish - Beige



Finish - Mocha

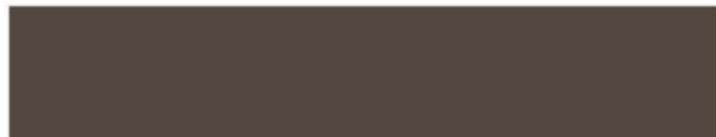

Finish - White

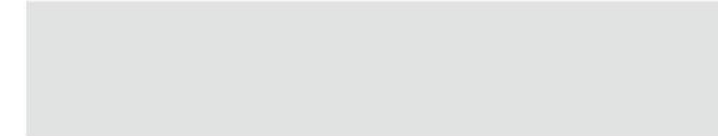

Finish - Light Wooden



Note:
Actual finish may vary from the images shown.

Slimtek Drawer 88mm



Specification

- > Available Depth 12, 14, 16, 18, 20 & 22 inches.
- > Full extension drawer slides with soft closing.
- > Made from high quality metal with new improved technology
- > Drawer height 88mm
- > Weight capacity up to 35kg
- > Precise alignment with 3D adjustment
- > 60,000 life cycle tested
- > Finish - Dark Grey



Slimtek Drawer 120mm



Specification

- > Available Depth 12, 14, 16, 18, 20 & 22 inches.
- > Full extension drawer slides with soft closing.
- > Made from high quality metal with new improved technology
- > Drawer height 120mm
- > Weight capacity up to 35kg
- > Precise alignment with 3D adjustment
- > 60,000 life cycle tested
- > Finish - Dark Grey



Slimtek Drawer 184mm



Specification

- > Available Depth 12, 14, 16, 18, 20 & 22 inches.
- > Full extension drawer slides with soft closing.
- > Made from high quality metal with new improved technology
- > Drawer height 184mm
- > Weight capacity up to 35kg
- > Precise alignment with 3D adjustment
- > 60,000 life cycle tested
- > Finish - Dark Grey

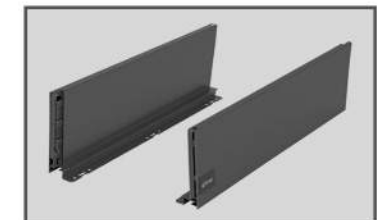

Slimtek Drawer 248mm



Specification

- > Available Depth 18, 20 & 22 inches.
- > Full extension drawer slides with soft closing.
- > Made from high quality metal with new improved technology
- > Drawer height 248mm
- > Weight capacity up to 35kg
- > Precise alignment with 3D adjustment
- > 60,000 life cycle tested
- > Finish - Dark Grey



Slimtek Front Panel



Specification

- > Front panel size H-107mm x L-1000mm
- > Front panel size H-140mm x L-1000mm
- > Made from high quality metal with new improved technology
- > Suitable for drawer height 88mm & 120mm
- > Finish - Dark Grey
- > Suitable for all depths 12, 14, 16, 18, 20 & 22"

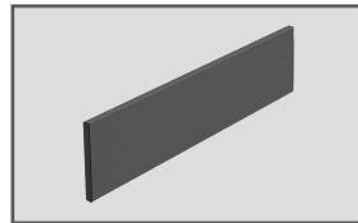

Slimtek Glass Front Panel



Specification

- > Glass front panel size H-150mm x L-600mm
- > Glass front panel size H-210mm x L-600mm
- > Glass front panel size H-150mm x L-1000mm
- > Glass front panel size H-210mm x L-1000mm
- > Made from high quality metal with new improved technology
- > Suitable for drawer height 120mm & 184mm
- > Finish - Dark Grey
- > Suitable for all depths 12, 14, 16, 18, 20 & 22"



Slimtek Cutlery Tray



Specification

- > High quality aluminum material.
- > Reasonably dividing the internal space.
- > Perfect function of drawer.
- > Durable for use.

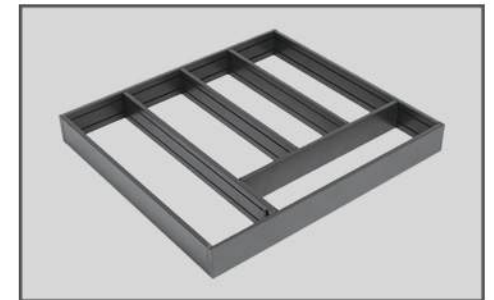

Cabinet width:400mm

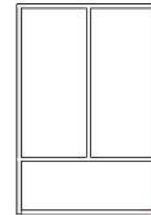

Nominal Length	Size (W-D-H)
500mm	313mm x 474mm x 60mm
500mm	313mm x 474mm x 60mm

Cabinet width:450mm

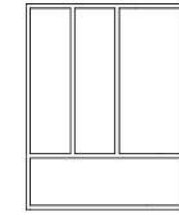

Nominal Length	Size (W-D-H)
500mm	363mm x 424mm x 60mm
500mm	363mm x 424mm x 60mm

Cabinet width:500mm

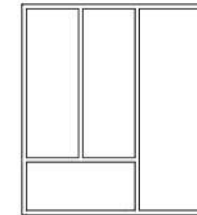

Nominal Length	Size (W-D-H)
500mm	413mm x 474mm x 60mm
500mm	413mm x 474mm x 60mm

Cabinet width:550mm

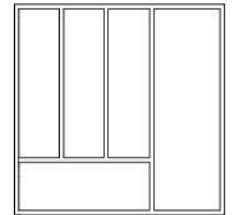

Nominal Length	Size (W-D-H)
500mm	463mm x 474mm x 60mm
500mm	463mm x 474mm x 60mm

Cabinet width:600mm

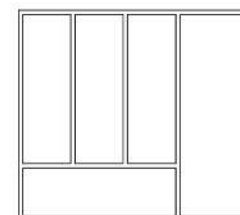

Nominal Length	Size (W-D-H)
500mm	513mm x 474mm x 60mm
500mm	513mm x 524mm x 60mm

Cabinet width:650mm

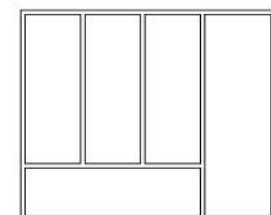

Nominal Length	Size (W-D-H)
500mm	563mm x 474mm x 60mm
500mm	563mm x 524mm x 60mm

Cabinet width:700mm

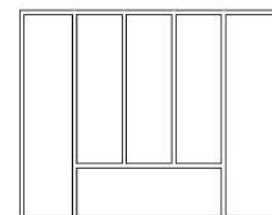

Nominal Length	Size (W-D-H)
500mm	613mm x 474mm x 60mm
500mm	613mm x 524mm x 60mm

Cabinet width:750mm

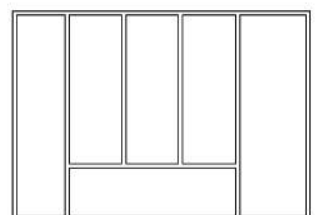

Nominal Length	Size (W-D-H)
500mm	663mm x 474mm x 60mm
500mm	663mm x 524mm x 60mm

Cabinet width:800mm

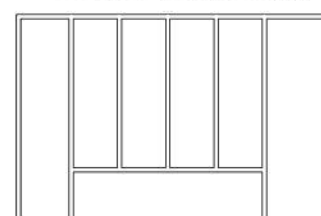

Nominal Length	Size (W-D-H)
500mm	713mm x 474mm x 60mm
500mm	713mm x 524mm x 60mm

Cabinet width:850mm

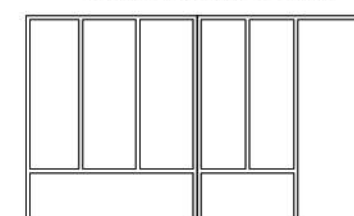

Nominal Length	Size (W-D-H)
500mm	763mm x 474mm x 60mm
500mm	763mm x 524mm x 60mm

Cabinet width:900mm



Nominal Length	Size (W-D-H)
500mm	813mm x 474mm x 60mm
500mm	813mm x 524mm x 60mm

Slimtek Pullout



Specification

- > Available in depths: 450, 500 & 550mm
- > Top panels height 88mm
- > Bottom panels height 184mm
- > Best use for narrow cabinet size in kitchen
- > Full extension drawer slides for soft closing
- > 60,000 life cycle tested
- > Finish - Dark Grey



DRBX with 80mm RCB
(Metalic Grey)



Specification

- > Standard Lengths: 300, 350, 400, 450, 500, 550mm
- > Drawer side panel height 80mm.
- > Weight carrying capacity up to 35kg.
- > Easy, Quick installation and precise alignment.
- > 60,000 life cycle test certified.
- > Silent & ultra-smooth soft closing runner.
- > Modern design with larger internal drawer space & compatible drilling.

Side Panel

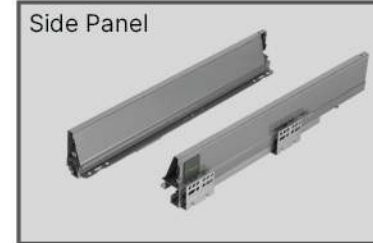

80mm RCB

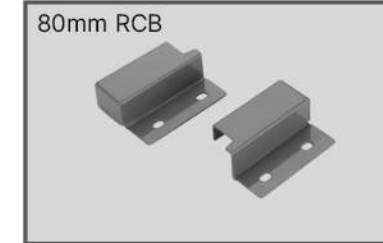

DRBX with 80mm RCB
(White)



Specification

- > Standard Lengths: 300, 350, 400, 450, 500, 550mm
- > Drawer side panel height 80mm.
- > Weight carrying capacity up to 35kg.
- > Easy, Quick installation and precise alignment.
- > 60,000 life cycle test certified.
- > Silent & ultra-smooth soft closing runner.
- > Modern design with larger internal drawer space & compatible drilling.

Side Panel



128mm RCB



DRBX with 128mm & 148mm RCB

(Metalic Grey)



Specification

- > Standard Lengths: 300, 350, 400, 450, 500, 550mm
- > Drawer side panel height 80mm.
- > Weight carrying capacity up to 35kg.
- > Easy, Quick installation and precise alignment.
- > 60,000 life cycle test certified.
- > Silent & ultra-smooth soft closing runner.
- > Modern design with larger internal drawer space & Compatible drilling.
- > Gallery Rail available in square shape & matching finish of DRBX.

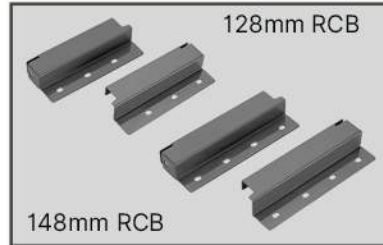
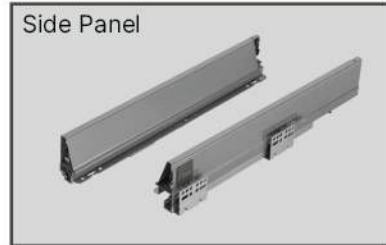

DRBX with 206mm RCB

(Metalic Grey)



Specification

- > Standard Lengths:300, 350, 400, 450, 500, 550mm
- > Drawer side panel height 80mm.
- > Weight carrying capacity up to 35kg.
- > Easy, Quick installation and precise alignment.
- > 60,000 life cycle test certified.
- > Silent & ultra-smooth soft closing runner.
- > Modern design with larger internal drawer space & Compatible drilling.
- > Gallery Rail available in square shape & matching finish of DRBX.

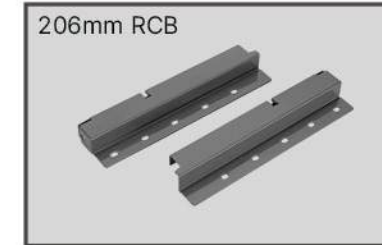
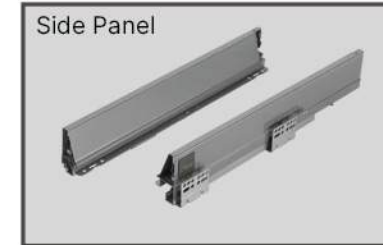

DRBX with 128mm & 148mm RCB

(White)



Specification

- > Standard Lengths: 300, 350, 400, 450, 500, 550mm
- > Drawer side panel height 80mm.
- > Weight carrying capacity up to 35kg.
- > Easy, Quick installation and precise alignment.
- > 60,000 life cycle test certified.
- > Silent & ultra-smooth soft closing runner.
- > Modern design with larger internal drawer space & Compatible drilling.
- > Gallery Rail available in square shape & matching finish of DRBX.

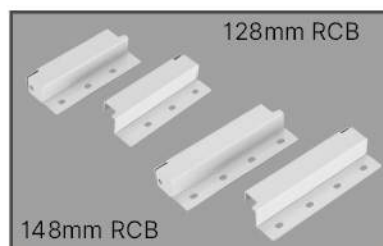
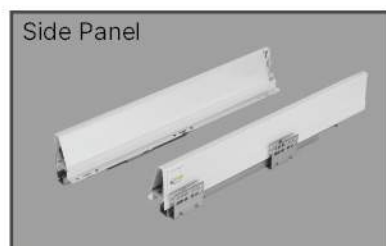

DRBX with 206mm RCB

(White)



Specification

- > Standard Lengths:300, 350, 400, 450, 500, 550mm
- > Drawer side panel height 80mm.
- > Weight carrying capacity up to 35kg.
- > Easy, Quick installation and precise alignment.
- > 60,000 life cycle test certified.
- > Silent & ultra-smooth soft closing runner.
- > Modern design with larger internal drawer space & Compatible drilling.
- > Gallery Rail available in square shape & matching finish of DRBX.





Cutlery Tray For DRBX

Width (mm)	Depth (mm)	Height (mm)
370, 420, 470, 520, 610, 660, 700, 760, 810	385, 485 535, 585	90

- Drawer side panel height 80mm.
- Suitable for Metallic Grey & White Finish.



Cup & Saucer Stand For DRBX

Width (mm)	Depth (mm)	Height (mm)
90 90	370, 420 470, 520	85 85

- Drawer side panel height 80mm.
- Suitable for Metallic Grey & White Finish.

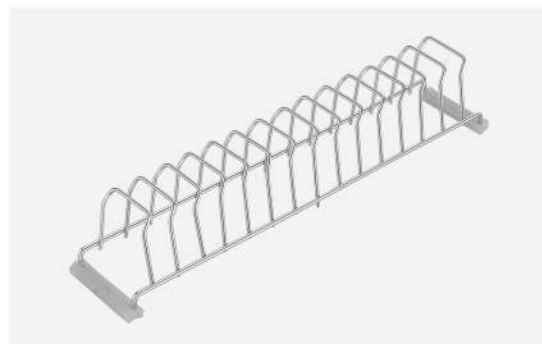

Thali-Plate Stand For DRBX

Width (mm)	Depth (mm)	Height (mm)
130 130	370, 420 470, 520	130 130

- Drawer side panel height 80mm.
- Suitable for Metallic Grey & White Finish.

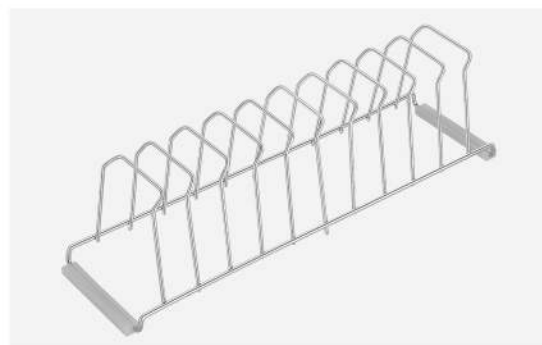

106mm GLS Front Drawer



132mm GLS Front Drawer



162mm GLS Front Drawer

Specification

- › Made with durable ABS with an elegant glass design
- › Perfect match for all types of modern kitchen, living room, bedroom and office drawers
- › Glass Front Drawer Option: Yes available with Side and back glass
- › Finish: Grey with clear glass
- › Weight Capacity: up to 35kg
- › Runner: Yes, full extension with soft close

Width (inch)	Width (mm)	Depth (mm)
18	450-900	455
20	450-900	505
22	450-900	555



106mm GLS Inner Drawer



132mm GLS Inner Drawer



162mm GLS Inner Drawer

Specification

- › Made with durable ABS with an elegant glass design
- › Perfect match for all types of modern kitchen, living room, bedroom and office drawers
- › Inner Glass Drawer Option: Yes available with front and back glass
- › Finish: Grey with clear glass
- › Weight Capacity: up to 35kg
- › Runner: Yes, full extension with soft close

Width (inch)	Width (mm)	Depth (mm)
18	450-900	455
20	450-900	505
22	450-900	555



106mm GLS Back Wooden Drawer



132mm GLS Back Wooden Drawer



162mm GLS Back Wooden Drawer

Specification

- › Made with durable ABS with an elegant glass design
- › Perfect match for all types of modern kitchen, living room, bedroom and office drawers
- › Glass Back Wooden Drawer Option: Yes available with side glass
- › Finish: Grey with clear glass
- › Weight Capacity: up to 35kg
- › Runner: Yes, full extension with soft close

Width (inch)	Width (mm)	Depth (mm)
18	450-900	455
20	450-900	505
22	450-900	555



Cutlery Tray

Width (mm)	Depth (mm)	Depth (inch)
380-550, 530-620, 620-850	423, 473, 523	18", 20", 22"



Gallery For GLS Wooden Back Drawer

Depth (mm)	Depth (inch)
455, 505, 555	18", 20", 22"

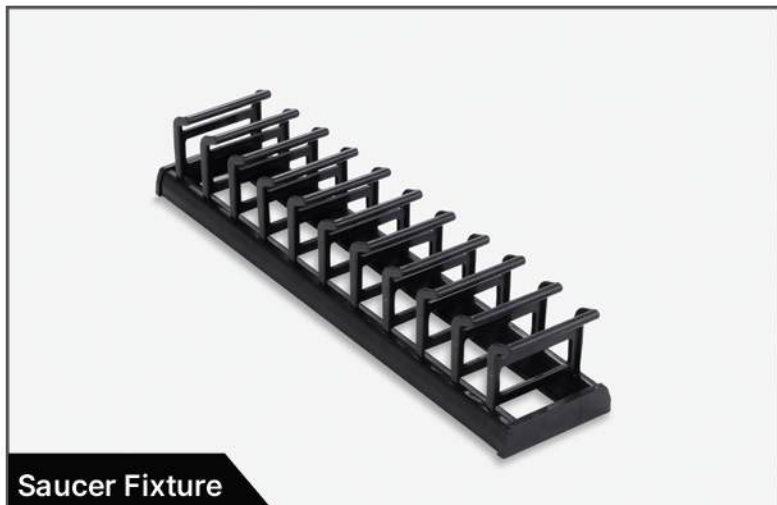

Saucer Fixture

Depth (mm)	Depth (inch)
425, 475, 525	18", 20", 22"

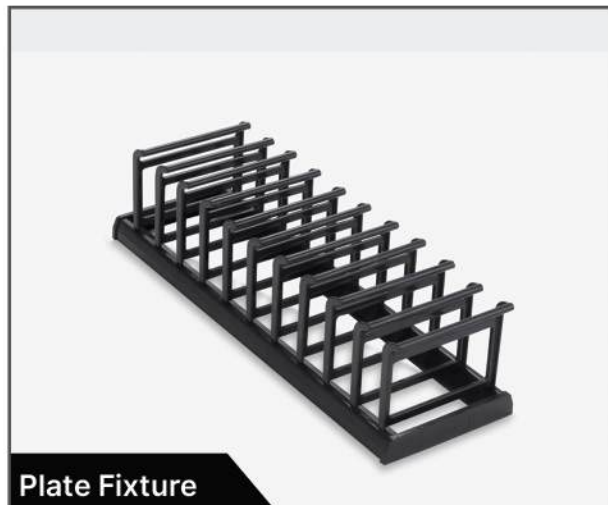

Plate Fixture

Depth (mm)	Depth (inch)
425, 475, 525	18", 20", 22"



Plain Basket (With Soft Close Slide)

Width (mm)	Depth (mm)	Height (mm)
380, 430, 480 & 530	400, 500 & 550	100



Plain Basket (With Soft Close Slide)

Width (mm)	Depth (mm)	Height (mm)
380, 430, 480 & 530	400, 500 & 550	150



Plain Basket (With Soft Close Slide)

Width (mm)	Depth (mm)	Height (mm)
380, 430, 480 & 530	400, 500 & 550	200





Cutlery Basket (With Soft Close Slide)

Width (mm)	Depth (mm)	Height (mm)
380, 430, 480 & 530	400, 500 & 550	100

Cutlery Tray

Width (mm)	Depth (mm)
335-265, 385-315,	485
430-460, 530-460, 630-560,	485
730-660, 830-760	485

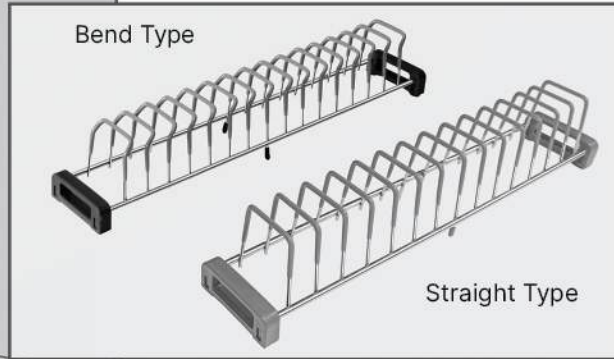

Cup & Saucer Basket (With Soft Close Slide)

Width (mm)	Depth (mm)	Height (mm)
380, 430, 480 & 530	400, 500 & 550	100

Cup & Saucer Stand

Width (mm)	Depth (mm)	Height (mm)
90	475, 525	100

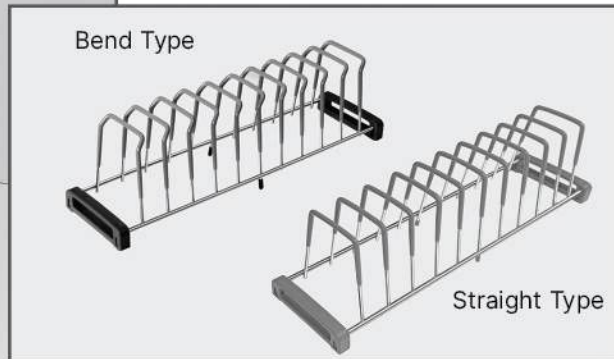

Thali-Plate Basket (With Soft Close Slide)

Width (mm)	Depth (mm)	Height (mm)
380, 430, 480 & 530	400, 500 & 550	200

Thali-Plate Stand

Width (mm)	Depth (mm)	Height (mm)
130	475, 525	140



Plain Basket (With Telescopic Slide)

Width (mm)	Depth (mm)	Height (mm)
380, 430, 480 & 530	400, 500, 550 & 600	100



Plain Basket (With Telescopic Slide)

Width (mm)	Depth (mm)	Height (mm)
380, 430, 480 & 530	400, 500, 550 & 600	150



Plain Basket (With Telescopic Slide)

Width (mm)	Depth (mm)	Height (mm)
380, 430, 480 & 530	400, 500, 550 & 600	200

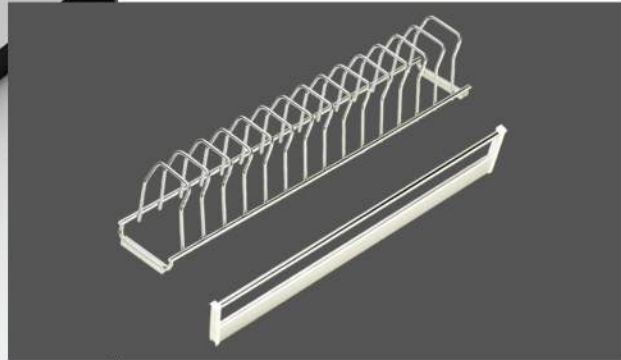

Cup & Saucer Basket

Width (mm)	Depth (mm)	Height (mm)
370, 420, 470 & 520	385, 485, 535 & 585	90

Cup & Saucer Stand

Width (mm)	Depth (mm)	Height (mm)
90	385, 485, 535, 585	85

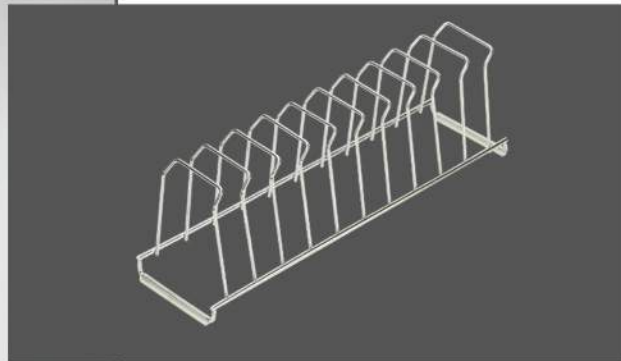

Thali Plate Basket

Width (mm)	Depth (mm)	Height (mm)
370, 420, 470 & 520	385, 485, 535 & 585	130, 180

Thali-Plate Stand

Width (mm)	Depth (mm)	Height (mm)
130	385, 485, 535, 585	130

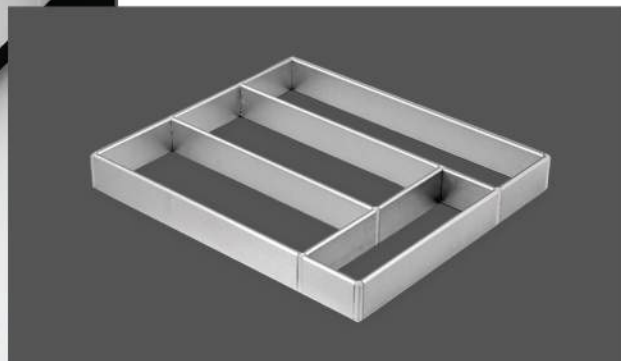

Cutlery Basket

Width (mm)	Depth (mm)	Height (mm)
370, 420, 470 & 520	385, 485, 535 & 585	90

Cutlery Tray

Width (mm)	Depth (mm)	Height (mm)
332, 382	347, 447	55
432, 482	497, 547	55

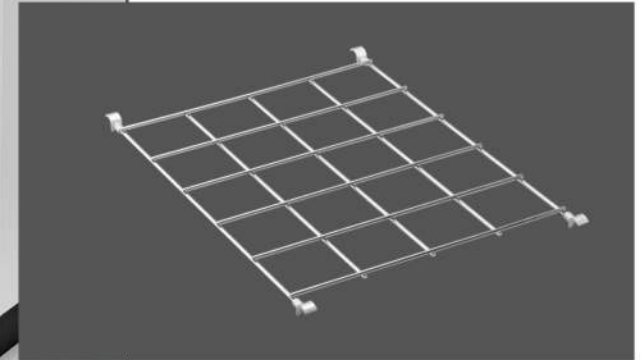

Glass Basket

Width (mm)	Depth (mm)	Height (mm)
370, 420, 470 & 520	385, 485, 535 & 585	90

Glass Stand

Width (mm)	Depth (mm)
370, 420	385, 485
470, 520	535, 585

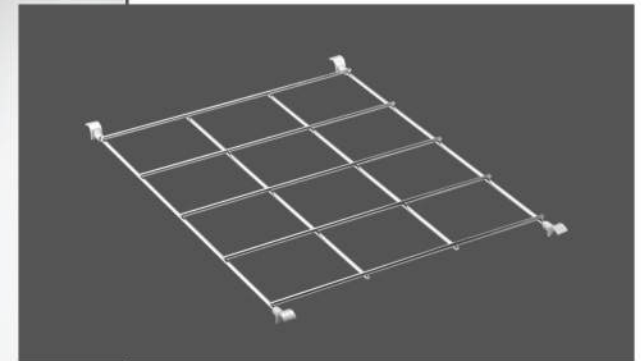

Bottle Basket

Width (mm)	Depth (mm)	Height (mm)
370, 420, 470 & 520	385, 485, 535 & 585	130, 180

Bottle Stand

Width (mm)	Depth (mm)
370, 420, 470, 520	385, 485, 535, 585



Partition Basket

Width (mm)	Depth (mm)	Height (mm)
370, 420, 470 & 520	385, 485, 535 & 585	90, 130 & 180

Basket Stand

Width (mm)	Height (mm)
385, 485, 535, 585	90, 130, 180



Plain Basket

Width (mm)	Depth (mm)	Height (mm)
228, 304, 370, 420, 470 & 520	385, 485, 535 & 585	90, 130 & 180



Grain Trolley (Without Soft-Close)

Width (mm)	Depth (mm)	Height (mm)
380, 430, 480 & 530	390, 490, 540 & 590	290



Pullout Basket

Width (mm)	Depth (mm)	Height (mm)
370, 420, 470, 520	385, 485	90, 130, 180
610, 710, 810, 910	535, 585	90, 130, 180



Two Shelf Pullout (Platinum Series)

Width (mm)	Depth (mm)	Height (mm)
120, 150, 200, 304	485	430



Three Shelf Pullout (Platinum Series)

Width (mm)	Depth (mm)	Height (mm)
120, 150, 200, 304	485	530



Detergent Pullout (Platinum Series)

Width (mm)	Depth (mm)	Height (mm)
120+120, 150+150, 150+200, 200+200	485, 535	430
	485, 535	430



M/P. Single Pullout (Platinum Series)

Width (mm)	Depth (mm)	Height (mm)
120, 150, 200	485, 535	585



ABS Glass

Carcass Width (mm)	Width (mm)	Depth (mm)	Height (mm)	Layer
200, 250, 300	160, 210, 260	485	485	2 Shelf
200, 250, 300	160, 210, 260	485	585	3 Shelf



MS Strip

Carcass Width (mm)	Width (mm)	Depth (mm)	Height (mm)	Layer
200, 250, 300	160, 210, 260	485	485	2 Shelf
200, 250, 300	160, 210, 260	485	585	3 Shelf



MDF Glass - 6 Layer

Carcass Width (mm)	Width (mm)	Depth (mm)	Height (mm)
200, 250, 300	160, 210, 260	485	1750



MS Strip - 6 Layer

Carcass Width (mm)	Width (mm)	Depth (mm)	Height (mm)
200, 250, 300	160, 210, 260	485	1750



MS Rod

Carcass Width (mm)	Width (mm)	Depth (mm)	Height (mm)	Layer
200, 250, 300, 400	160, 210, 260, 310	485	485	2 Shelf
200, 250, 300, 400	160, 210, 260, 310	485	585	3 Shelf



Metal base with Black Tinted Glass

Carcass Width (mm)	Width (mm)	Depth (mm)	Height (mm)	Layer
200, 250, 300, 400	160, 210, 260, 310	485	485	2 Shelf
200, 250, 300, 400	160, 210, 260, 310	485	585	3 Shelf



Single Pullout - Silver Strip (Platinum Series)

Width (mm)	Depth (mm)	Height (mm)
160, 210, 260	485	585

Make Every
Space
Delightfully
Special



*Neat
&
Stylish*



SMART ORGANIZER

Cutlery Tray - 20" Small

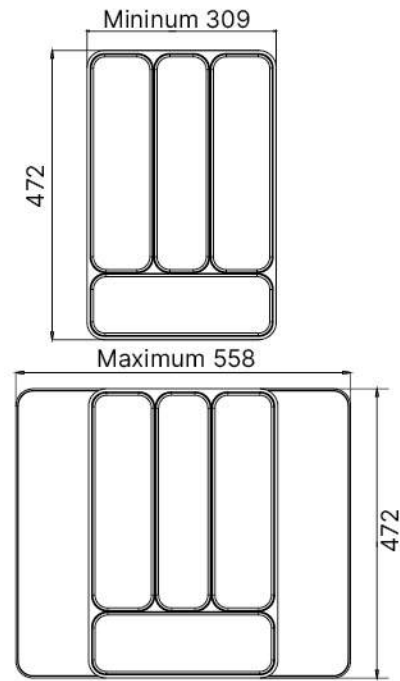

- Specifications:
- W-309 to 558mm x D-472mm x H-60mm
 - Suitable for carcass size of 400-600mm
 - Adjustable & Detachable as per drawer width.
 - Expandable sides for larger utensils.
 - Material - Premium Quality ABS



Cutlery Tray - 22"

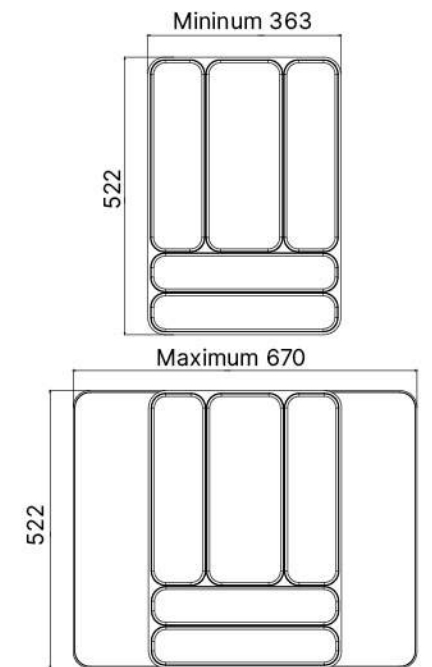

- Specifications:
- W-363 to 670mm x D-522mm x H-60mm
 - Suitable for carcass size of 450-750mm
 - Adjustable & Detachable as per drawer width.
 - Expandable sides for larger utensils.
 - Material - Premium Quality ABS



Cutlery Tray - 20" Big

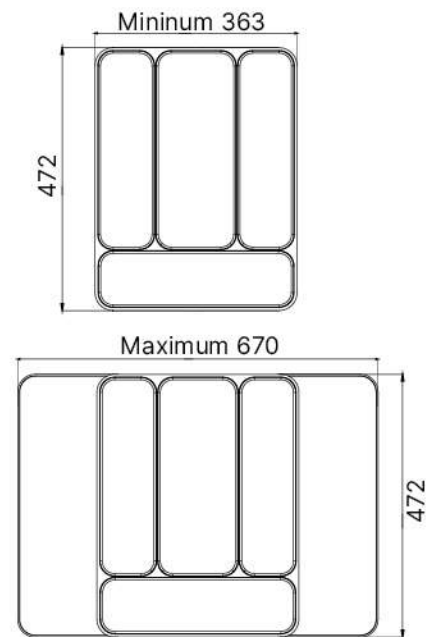

- Specifications:
- W-363 to 670mm x D-472mm x H-60mm
 - Suitable for carcass size of 450-750mm
 - Adjustable & Detachable as per drawer width.
 - Expandable sides for larger utensils.
 - Material - Premium Quality ABS



Cutlery Tray - 16"

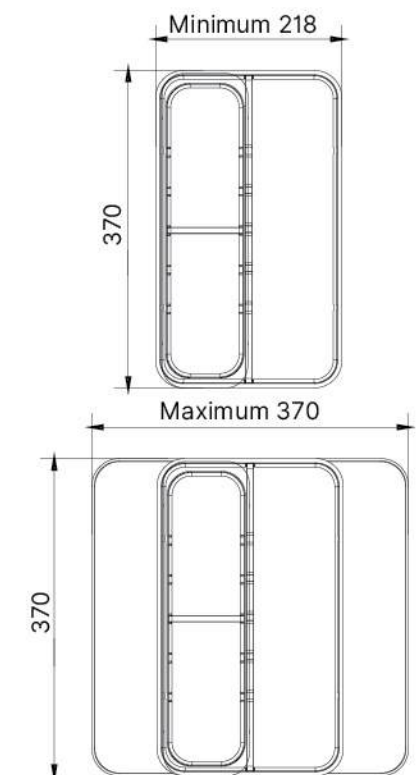

- Specifications:
- W-218 to 370mm x D-370mm x H-70mm
 - Suitable for carcass size of 300-450mm
 - Adjustable & Detachable as per drawer width.
 - Expandable sides for larger utensils.
 - Material - Premium Quality ABS

Extender Tray 20" | Extender Tray 22"

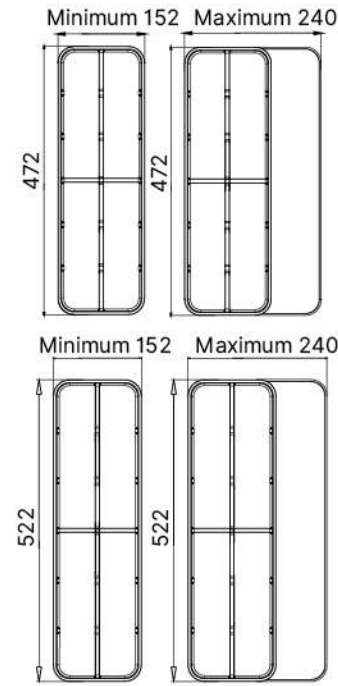

Specifications:

- W-152 to 240mm x D-472mm x H-60mm (20")
- W-152 to 240mm x D-522mm x H-60mm (22")
- Adjustable & Detachable as per drawer width.
- Expandable sides for larger utensils.
- Material - Premium Quality ABS

Extender Tray Uses

We at olive have thoughtfully created extender cutlery tray to utilise the extra space that is left unused in the drawer. These trays are available in two sizes in depth and are suitable for different drawer sizes in width. These trays can be used as an extension for your cutlery tray.



Cutlery Tray 20" - Small Extender Tray



Cutlery Tray 20" - Big Extender Tray 20"



Cutlery Tray 22" Extender Tray 22"

Specifications:

- W-461 Min. to 798mm
- Max. x D-472mm x H-60mm
- Extender tray use for 20" small cutlery tray

Specifications:

- W-515 Min. to 905mm
- Max. x D-472mm x H-60mm
- Extender tray use for 20" big cutlery tray

Specifications:

- W-515 Min. to 905mm
- Max. x D-522mm x H-60mm
- Extender tray use for 22" cutlery tray

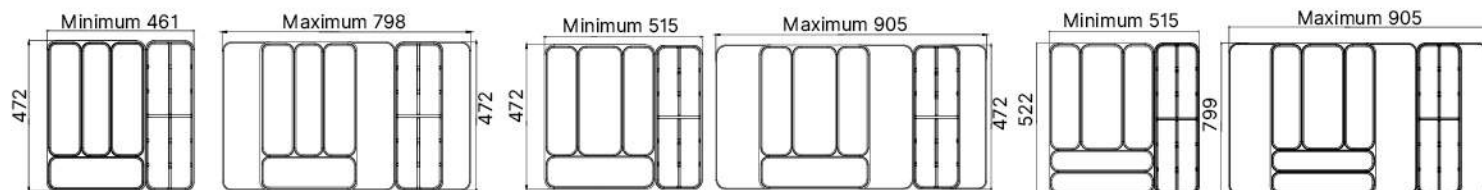

Spice Box Set - Horizontal

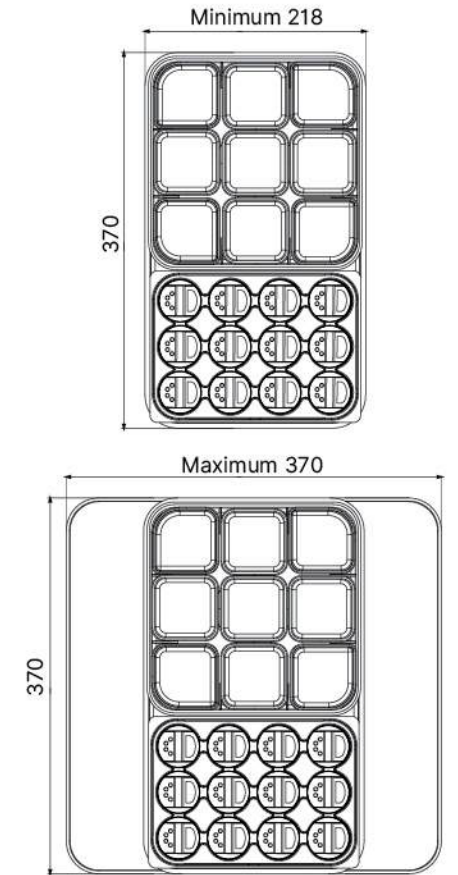

Specifications:

- W-218 to 370mm x D-370mm x H-116mm
- Individual compartments for different spices bottles.
- Spice Box Set are easy to wash & dries quickly.
- Material - Premium Quality ABS & PP

Spice Box Set - Vertical

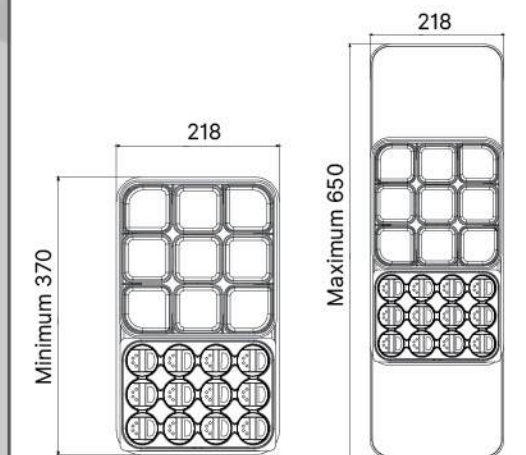

Specifications:

- W-218mm x D-370 to 650mm x H-116mm
- Individual compartments for different spices bottles.
- Spice Box Set are easy to wash & dries quickly.
- Material - Premium Quality ABS & PP

Spoon Rack

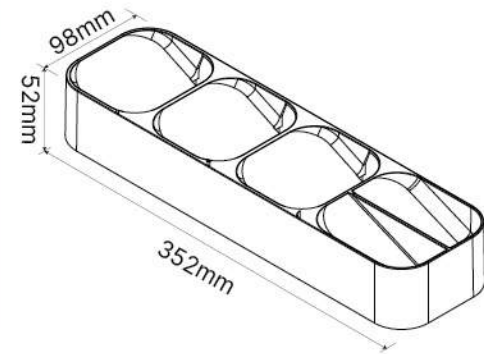

- Specifications:
- W-98mm x D-352mm x H-52mm
 - Individual, stacked compartments for different cutlery.
 - Systematic storage of your spoon, butter knives and fork.
 - Material - Premium Quality ABS
 - Non-slip feet.



Knife Holder

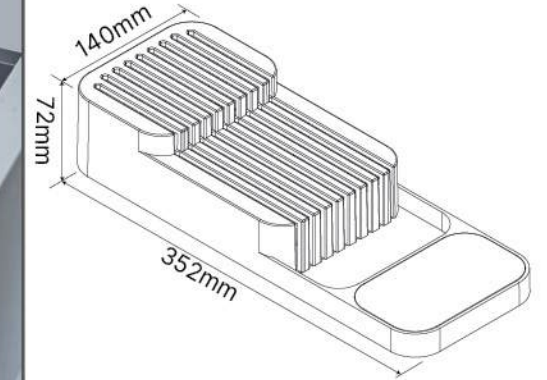

- Specifications:
- W-140mm x D-352mm x H-72mm
 - Individual compartments for different size of knives blades.
 - Knife Holder are easy to wash & dry quickly.
 - Material - Premium Quality ABS
 - Non-slip feet.



Spice Bottle Rack

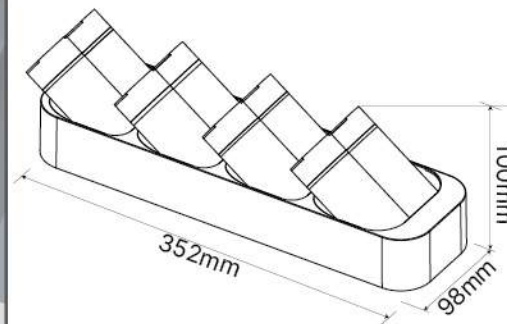

- Specifications:
- W-98mm x D-352mm x H-100mm
 - Individual compartments for different spices bottles.
 - Spice Bottle Rack are easy to wash & dries quickly.
 - Material - Premium Quality ABS & PP
 - Non-slip feet.

Multipurpose Tray 100mm - Vertical

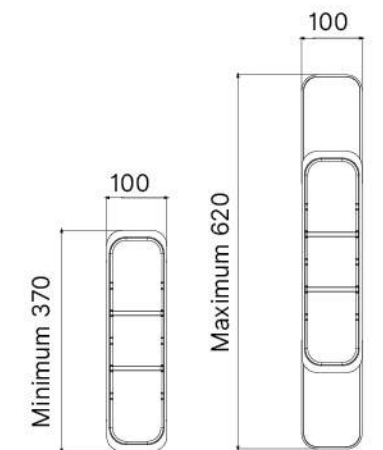

- Specifications:
- W-100mm x D-370 to 620mm x H-65mm
 - Adjustable & Detachable as per drawer width.
 - Expandable sides for larger utensils.
 - Material - Premium Quality ABS

Multipurpose Tray 170mm - Horizontal

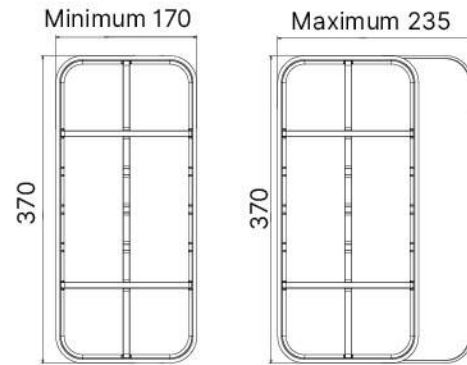

- Specifications:
- W-170 to 235mm x D-370mm x H-65mm
 - Adjustable & Detachable as per drawer width.
 - Expandable sides for larger utensils.
 - Material - Premium Quality ABS

Multipurpose Tray 218mm - Horizontal

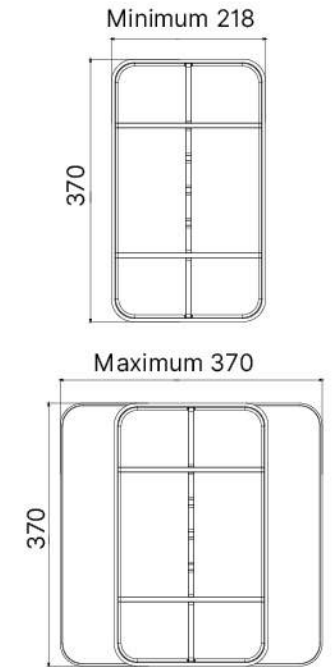

- Specifications:
- W-218 to 370mm x D-370mm x H-65mm
 - Adjustable & Detachable as per drawer width.
 - Expandable sides for larger utensils.
 - Material - Premium Quality ABS

Multipurpose Tray 218mm - Vertical

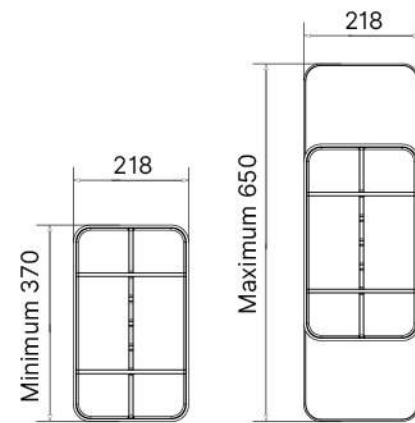

- Specifications:
- W-218mm x D-370 to 650mm x H-65mm
 - Adjustable & Detachable as per drawer width.
 - Expandable sides for larger utensils.
 - Material - Premium Quality ABS

Other Utilities

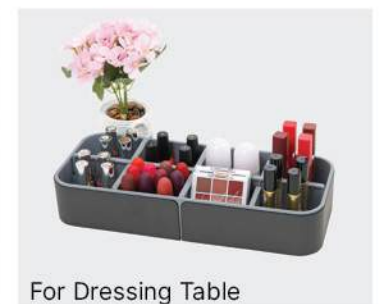
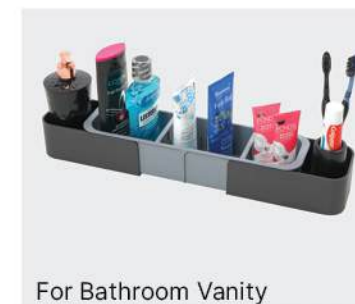



Hanging Rack - 01

Width	Depth	Height
350mm	110mm	140mm

- Ideal for oil, jam, pickle, sauce & ketchup bottles.
- Standard quality MS material.
- Finish - Dark Grey



Hanging Rack - 02

Width	Depth	Height
350mm	110mm	200mm

- Ideal for oil, jam, pickle, sauce & ketchup bottles.
- Standard quality MS material.
- Finish - Dark Grey



Hanging Rack - 03

Width	Depth	Height
350mm	110mm	300mm

- Ideal for oil, jam, pickle, sauce & ketchup bottles.
- Standard quality MS material.
- Finish - Dark Grey



Bowl Basket Rack

Width	Depth	Height
350mm	100mm	150mm

- Ideal for vegetable peeler, grater, brushes, lighter etc.
- Standard quality MS material.
- Finish - Dark Grey



Hanging Single Rack

Width	Depth	Height
350mm	100mm	250mm

- Ideal for oil, jam, pickle, sauce & ketchup bottles.
- Standard quality MS material.
- Finish - Dark Grey



Hanging Double Rack

Width	Depth	Height
350mm	150mm	350mm

- Ideal for oil, jam, pickle, sauce & ketchup bottles.
- Standard quality MS material.
- Finish - Dark Grey



Multipurpose Rack

Width	Depth	Height
440mm	110mm	220mm

- Ideal for spice bottles, spoon & fork, napkins, spatula, small jars etc.
- Standard quality MS material.
- Finish - Dark Grey



Tissue Roll Holder

Width	Depth	Height
350mm	167mm	126mm

- Ideal for different types of tissue roll.
- Standard quality MS material.
- Finish - Dark Grey



Hanging Spoon Rack

Width	Depth	Height
240mm	50mm	40mm

- Ideal for spatula, ladle, brushes & strainer.
- Standard quality MS material.
- Finish - Dark Grey



Top Plate

Width	Depth	Height
350mm	104mm	20mm

- Ideal for decorative items & small kitchen tools.
- Standard quality MS material.
- Finish - Dark Grey

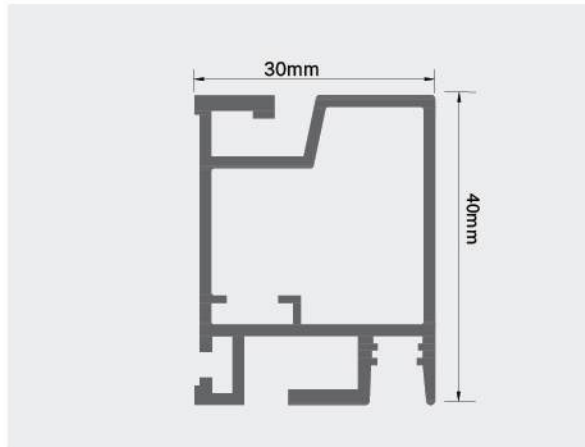

Midway Unit Profile

Width	Depth	Height
900mm	30mm	40mm
1200mm	30mm	40mm

- Standard quality Aluminum material.
- Finish - Dark Grey

“Designed For Comfort
Build To Impress”



CONCEPT - 01

Note: The 3 concept product images shown are for reference purpose only.



CONCEPT - 02

Note: The 3 concept product images shown are for reference purpose only.



CONCEPT - 03



JAR ORGANIZERS

A Jar Organizer is a storage solution designed to neatly arrange spice jars, dry fruits, pulses, condiments, and other small kitchen essentials. It saves time, improves accessibility, and keeps the kitchen clutter-free.

Key Benefits our Jars:

- Space Saving: Utilises vertical or drawer space efficiently.
- Easy Access: Transparent lid for quick identification.
- Neat & Tidy: Prevents clutter and makes the kitchen look organised.
- Multi-Purpose Use: Suitable for spices, grains, dry fruits, snacks, and more.
- Durability: Made from strong materials for long-term use.
- Material: Polycarbonate & unbreakable.
- Air tight containers.



JAR ORGANIZER INSTALLATION VIDEO



Jar Capacities



Jar Organizer S-OJ4

Size in mm (W x D x H)	Suitable For	Capacity Per Jar
126 x 525 x 84	6" Drawer	400gm



Jar Organizer S-OJ7

Size in mm (W x D x H)	Suitable For	Capacity Per Jar
280 x 525 x 84	6" Drawer	400gm & 800gm



Jar Organizer S-OJ16

Size in mm (W x D x H)	Suitable For	Capacity Per Jar
508 x 525 x 84	6" Drawer	400gm
(Suitable for 600mm cabinet)		



Jar Organizer S-OJ3

Size in mm (W x D x H)	Suitable For	Capacity Per Jar
157 x 525 x 84	6" Drawer	800gm



Jar Organizer S-OJ8

Size in mm (W x D x H)	Suitable For	Capacity Per Jar
254 x 525 x 84	6" Drawer	400gm



Jar Organizer S-OJ22

Size in mm (W x D x H)	Suitable For	Capacity Per Jar
808 x 525 x 84	6" Drawer	400gm & 800gm
(Suitable for 900mm cabinet)		

*S = Short | T = Tall | O = Olive | J = Jars | 3,4,7,8,16,22 = No.of Jars



Jar Organizer T-OJ4

Size in mm (W x D x H)	Suitable For	Capacity Per Jar
126 x 525 x 184	8" Drawer	1kg



Jar Organizer T-OJ3

Size in mm (W x D x H)	Suitable For	Capacity Per Jar
157 x 525 x 184	8" Drawer	2kg



Jar Organizer T-OJ7

Size in mm (W x D x H)	Suitable For	Capacity Per Jar
280 x 525 x 184	8" Drawer	1kg & 2kg



Jar Organizer T-OJ8

Size in mm (W x D x H)	Suitable For	Capacity Per Jar
254 x 525 x 184	8" Drawer	1kg



Jar Organizer T-OJ16

Size in mm (W x D x H)	Suitable For	Capacity Per Jar
508 x 525 x 184	8" Drawer	1kg
(Suitable for 600mm cabinet)		



Jar Organizer T-OJ22

Size in mm (W x D x H)	Suitable For	Capacity Per Jar
808 x 525 x 184	8" Drawer	1kg & 2kg
(Suitable for 900mm cabinet)		

*S = Short | T = Tall | O = Olive | J = Jars | 3,4,7,8,16,22 = No.of Jars





Swing Tray (Emperor Series)

Swing Tray (Smartek Series)



Swing Tray (Diamond Series)



Swing Tray (Royale Series)

Cabinet Size	Width x Depth x Height	Description
1050-1100mm	Dia. 815 x 400 x (600-700)mm = 2 Layer	Left - Right Opening
1050-1100mm	Dia. 815 x 400 x (1100-1200)mm = 4 Layer	Left - Right Opening

SWING TRAY
INSTALLATION VIDEO



Metal Base with Black Tinted Glass (G-Titan Series)



Double Strip (Smartek Series)



MS Rod (Prime Series)



ABS Glass (Smartek Series)



Double Strip (Platinum Series)

Cabinet Size	Width x Depth x Height	Description
1050-1100 x 560 x 720mm	660 x 515 x 600mm	Universal - 2 Layer

SHOW HAND CORNER
INSTALLATION VIDEO



“Transform Corners Into
Culinary Comfort”

ABS Glass (Smartek Series)



Double Strip (Smartek Series)



Double Strip (Platinum Series)



MS Road (Prime Series)

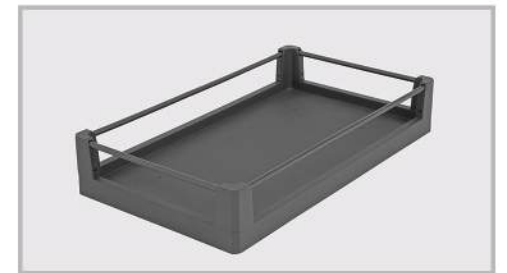

TANDEM PANTRY UNIT
INSTALLATION VIDEO



450MM 600MM

Cabinet Size (mm)	Width x Depth x Height (mm)	Description
450	380 x 510 x 1130	4 Layers
450	380 x 510 x 1430	5 Layers
450	380 x 510 x 1820	6 Layers
600	480 x 510 x 1130	4 Layers
600	480 x 510 x 1430	5 Layers
600	480 x 510 x 1820	6 Layers

TANDEM PANTRY UNIT
INSTALLATION VIDEO



450MM 600MM

Cabinet Size (mm)	Width x Depth x Height (mm)	Description
450	380 x 510 x 1130	4 Layers
450	380 x 510 x 1430	5 Layers
450	380 x 510 x 1820	6 Layers
600	480 x 510 x 1130	4 Layers
600	480 x 510 x 1430	5 Layers
600	480 x 510 x 1820	6 Layers



Metal base with Black Tinted Glass (G-Titan Series)

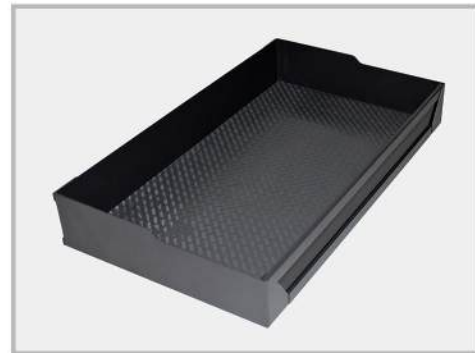

Specification

- › Front door attachment with dual motion system
- › Material: Metal base with Black Tinted Glass
- › Premium anti-skid mat Included
- › Finish: Matte
- › Loading capacity up to 50kg
- › 6 adjustable height baskets

Cabinet Size (mm)	Width x Depth x Height (mm)	Description
450	380 x 510 x 1130	4 Layers
450	380 x 510 x 1430	5 Layers
450	380 x 510 x 1820	6 Layers
600	480 x 510 x 1130	4 Layers
600	480 x 510 x 1430	5 Layers
600	480 x 510 x 1820	6 Layers

“More Storage In Small Space”



Finish - Grey

Cabinet Size For Rolling Shutter - Platinum

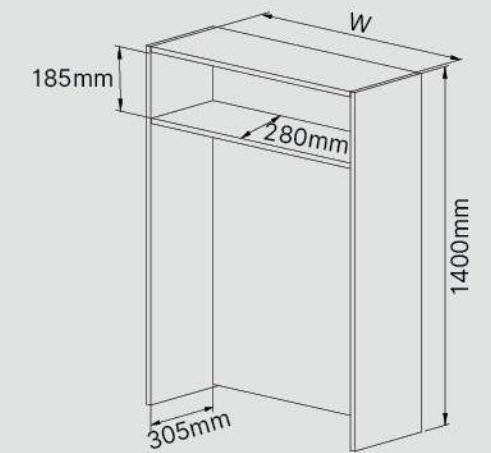

Width - 450 & 600mm



Finish - White



Finish - Black

Width (mm)	Depth (mm)	Height (mm)
450 & 600	350	1400

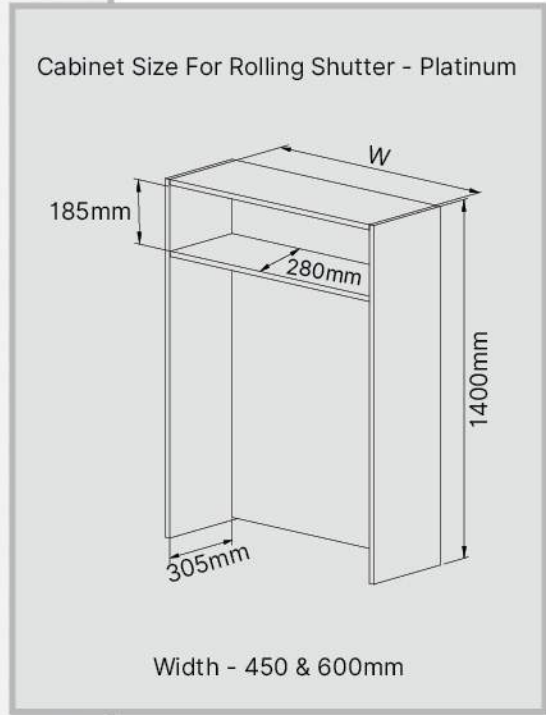

Width (mm)	Depth (mm)	Height (mm)
450 & 600	350	1400

Width (mm)	Depth (mm)	Height (mm)
450, 600, 900	350	1400

ROLLING SHUTTER
INSTALLATION VIDEO

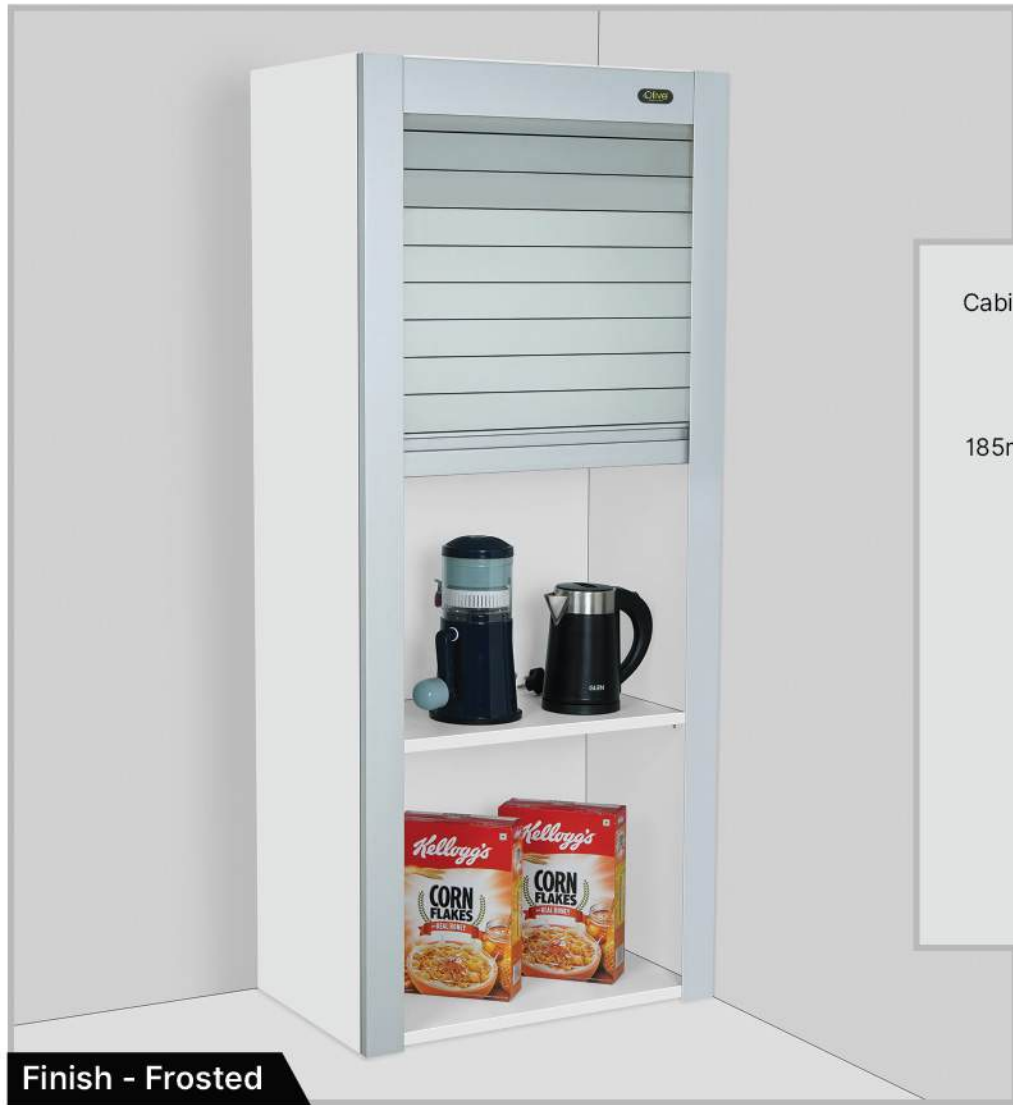

Finish - Frosted

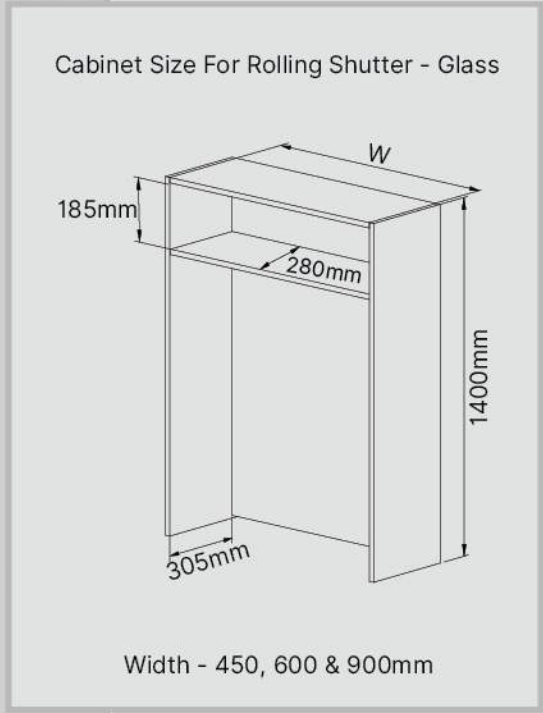

Finish - Champagne



Finish - Silver



Finish - White



Finish - Black



Finish - Black



Finish - White

Width (mm)	Depth (mm)	Height (mm)
450, 600, 900	350	1400

ROLLING SHUTTER
INSTALLATION VIDEO

Width (mm)	Depth (mm)	Height (mm)
450 & 600	350	1400

Wicker Basket With Aluminum Channel
Light Brown

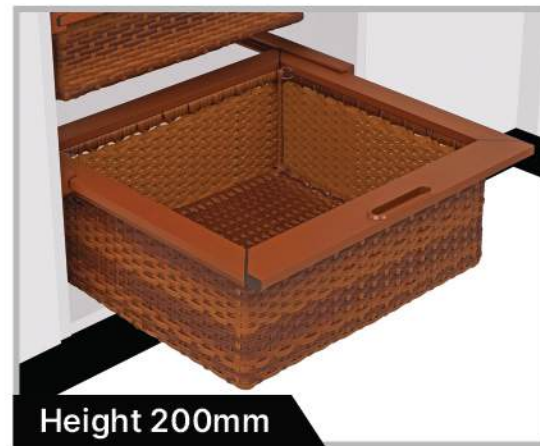
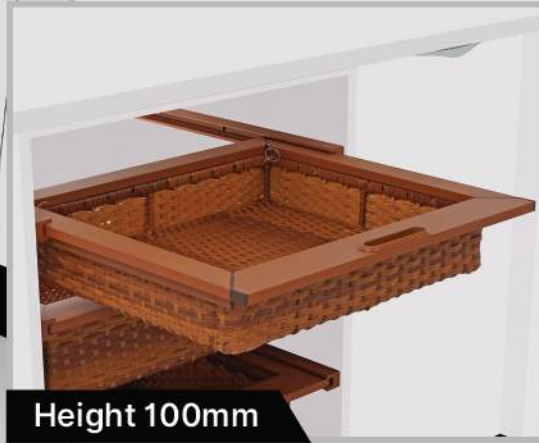

Cabinet Size (mm)	Width (mm)	Depth (mm)	Height (mm)
450	414	508	100, 150, 200
600	564	508	100, 150, 200

Wicker Basket With Soft Close Channel
Light Brown

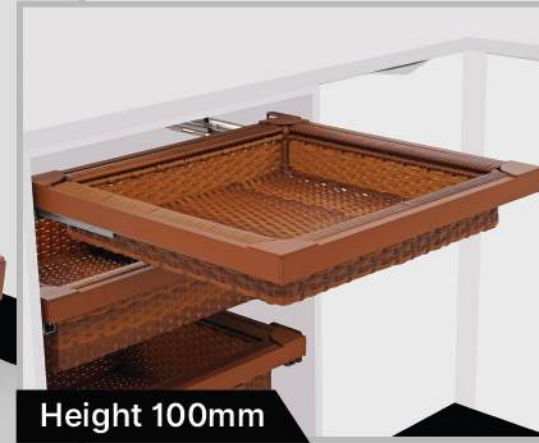

Note: Soft-close slide not included. To be purchased separately.

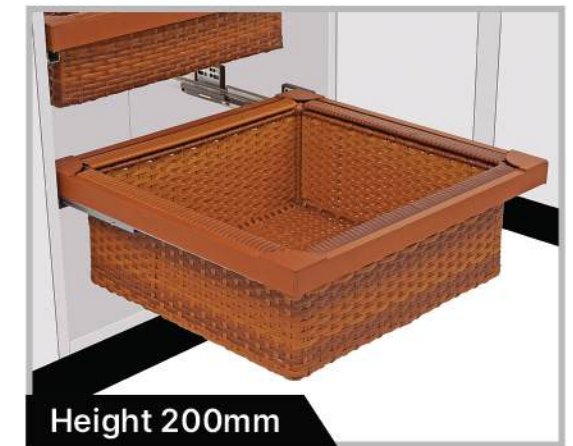
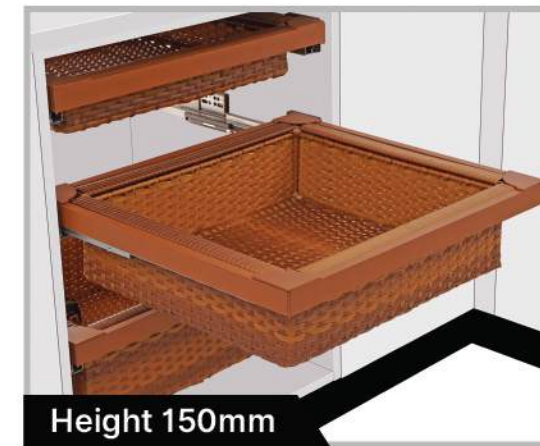

Cabinet Size (mm)	Width (mm)	Depth (mm)	Height (mm)
450	414	508	100, 150, 200
600	564	508	100, 150, 200

Wicker Basket With Aluminum Channel
Dark Brown



Wicker Basket With Soft Close Channel
Dark Brown



Note: Soft-close slide not included. To be purchased separately.

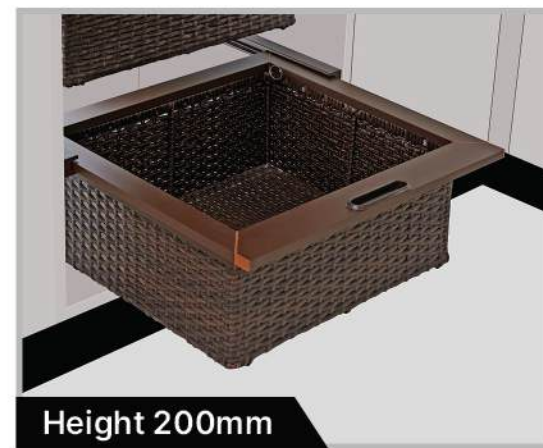

Cabinet Size (mm)	Width (mm)	Depth (mm)	Height (mm)
450	414	508	100, 150, 200
600	564	508	100, 150, 200

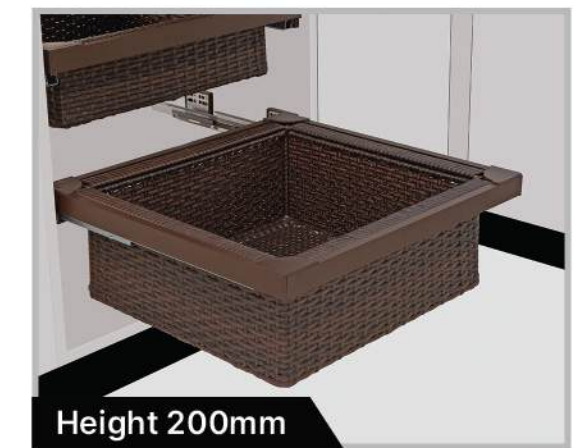

Cabinet Size (mm)	Width (mm)	Depth (mm)	Height (mm)
450	414	508	100, 150, 200
600	564	508	100, 150, 200

Wicker Basket With Partition
With Aluminum Channel

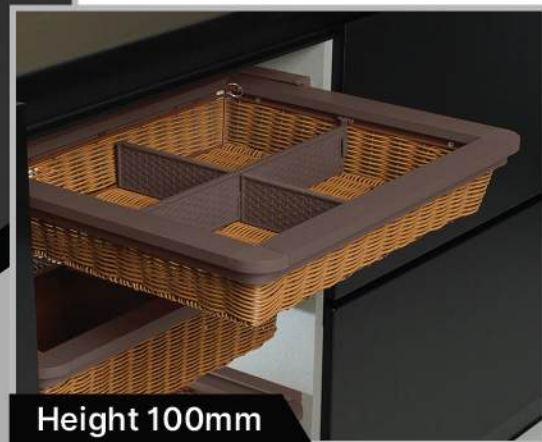

Height 100mm

Note: Wicker basket for a 450mm cabinet width, provided with a single partition only.

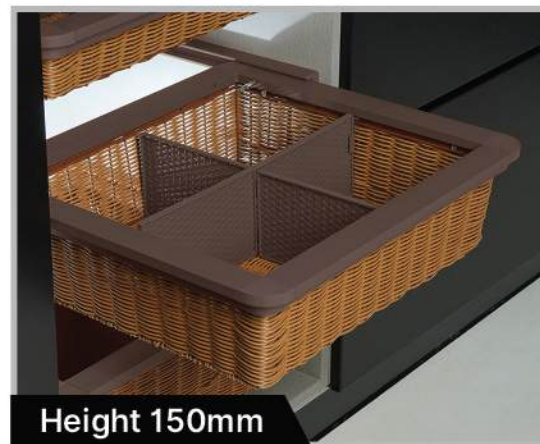

Height 150mm



Height 200mm

Cabinet Size (mm)	Width (mm)	Depth (mm)	Height (mm)
450	414	508	100, 150, 200
600	564	508	100, 150, 200

Wicker Basket With Partition
With Soft Close Channel

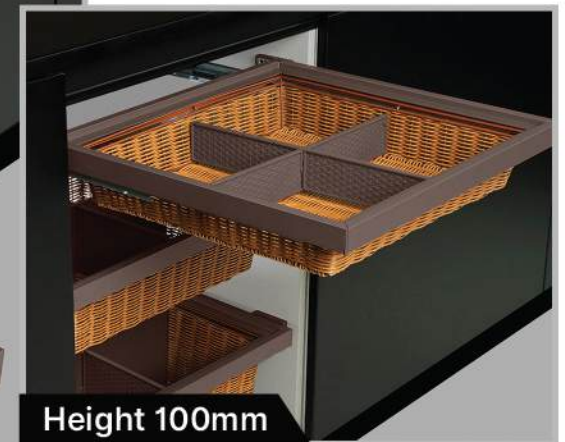

Height 100mm

Note: Wicker basket for a 450mm cabinet width, provided with a single partition only.
Note: Soft-close slide not included. To be purchased separately.

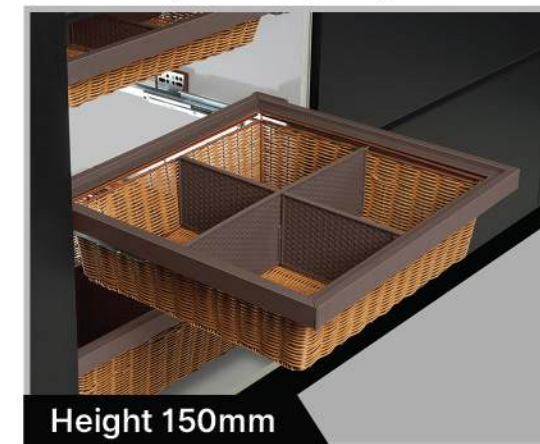

Height 150mm

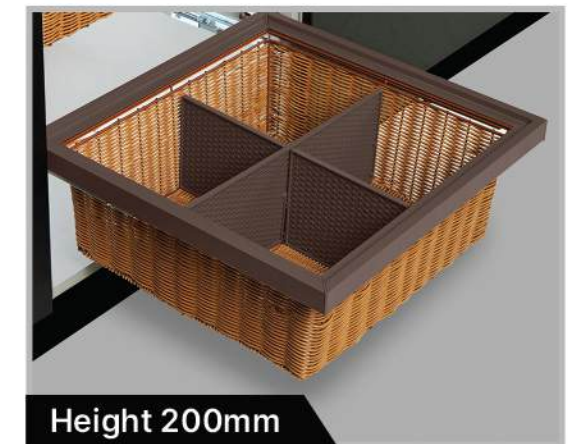

Height 200mm

Cabinet Size (mm)	Width (mm)	Depth (mm)	Height (mm)
450	414	508	100, 150, 200
600	564	508	100, 150, 200

Wardrobe Collection



LUXE SERIES



Specification

- › Made of robust metal to ensure long lasting durability and stability with high quality leather finish that provides a luxurious, premium feel while being durable.
- › Designed to organize and store jewellery, rings, watches, make up & other essentials in an elegant and efficient manner.
- › It features a variety of compartment of different sizes tailored to neatly organize various jewellery pieces, make up & other accessories.
- › Runners - Soft closing drawer slides
- › Weight Capacity - Upto 30 Kgs.
- › Finish - Tan

Cabinet Width	Width (mm)	Depth (mm)	Height (mm)
600	564	425, 475	65
900	864	425, 475	65

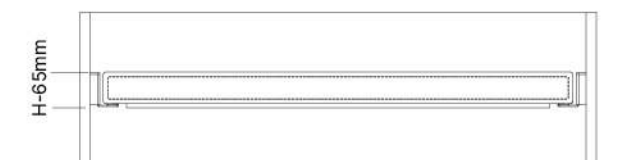
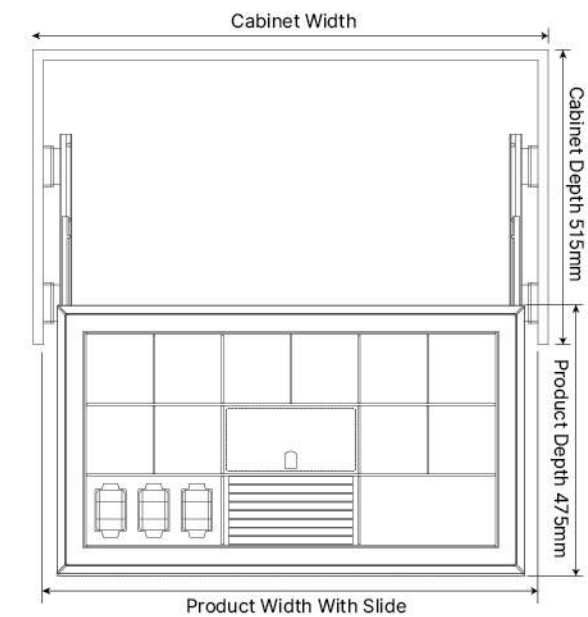



Specification

- › Designed to organize and store undergarments neatly & efficiently.
- › Sturdy metal frame with high quality leather that adds a premium & luxurious touch while offering durability & elegance.
- › Soft leather lined compartments to ensure delicate fabrics are maintained in pristine condition.
- › Runners - Soft closing drawer slides
- › Weight Capacity - Upto 30 Kgs.
- › Finish - Tan

Cabinet Width	Width (mm)	Depth (mm)	Height (mm)
600	564	475	100
900	864	475	100

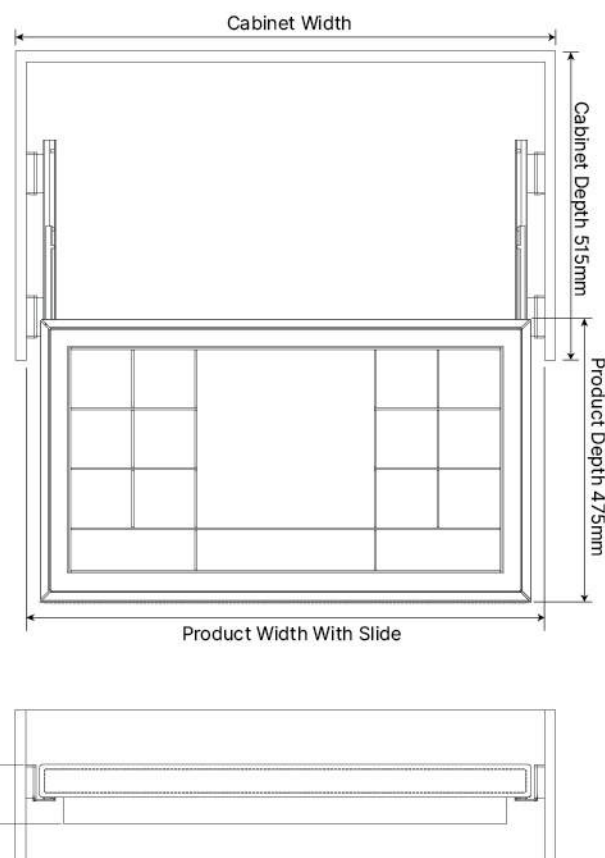

Specification

- › Can be placed anywhere in the wardrobe or drawer, offering flexibility in organizing items efficiently.
- › Designed to provide a versatile storage solution for jewellery, rings, make up, glasses & other small accessories inside drawer.
- › The tray can be adjusted between 480mm to 850mm in width making it suitable for various wardrobe sizes and storage spaces
- › High quality material with luxurious leather which provides premium look and offers protection from wear and dust.
- › Finish - Tan

Cabinet Width	Width (mm)	Depth (mm)	Height (mm)
600-900	480-850	410	70



Wardrobe Accessories

Leather Basket H-65mm

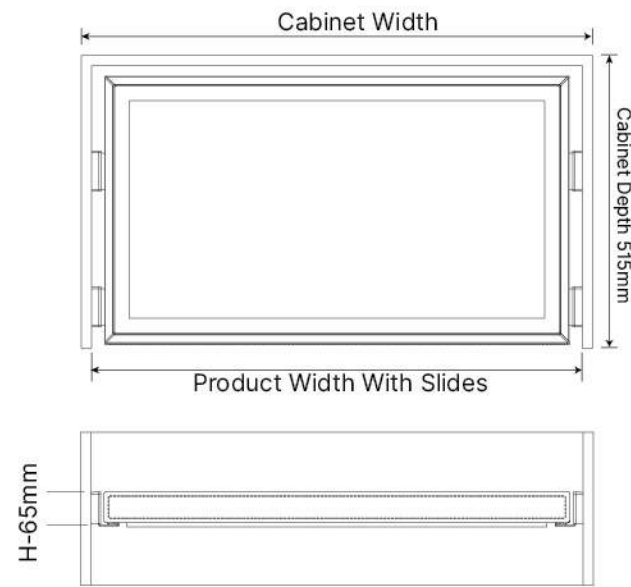

Specification

- › Crafted with high quality leather that adds an opulent, sophisticated touch to your wardrobe
- › Offers flexibility in organizing & storage space to suit your specific needs whether for clothes, accessories or smaller items.
- › Runners - Soft close drawer slides
- › Weight Capacity - Upto 30 Kgs.
- › Finish - Tan

Cabinet Width	Width (mm)	Depth (mm)	Height (mm)
600	564	425, 475	65
900	864	425, 475	65

Wardrobe Accessories

Glass Basket

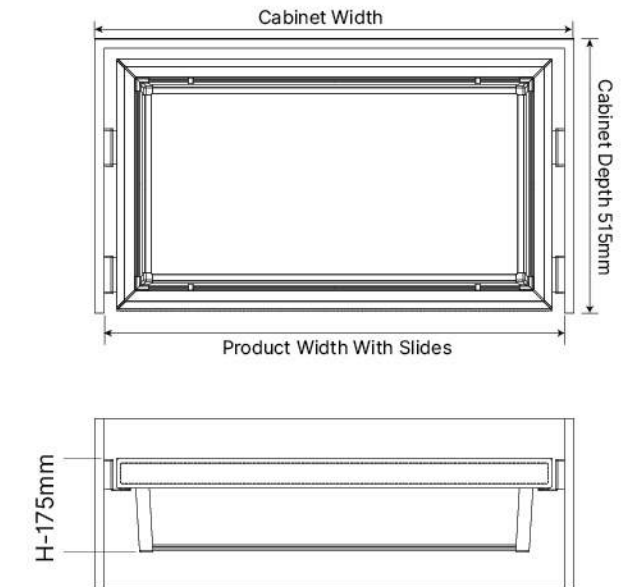
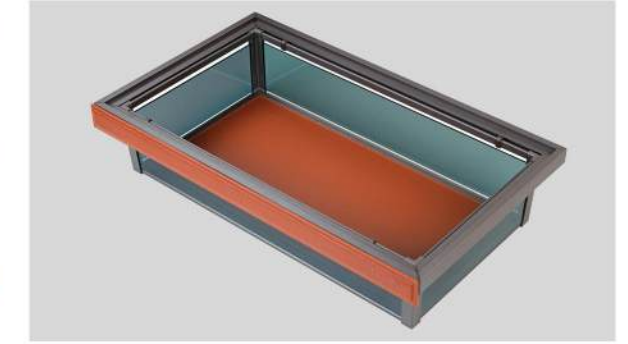

Specification

- › The wardrobe basket features glass panels on all sides, providing a look that enhances the aesthetics of your wardrobe or closet.
- › Constructed with high quality glass and sturdy material.
- › The smooth glass surface are simple to wipe & clean.
- › The combination of sleek glass gives modern touch to your wardrobe.
- › Weight Capacity - Upto 30 Kgs.
- › Finish - Tan & Mocha

Cabinet Width	Width (mm)	Depth (mm)	Height (mm)
600	564	475	175
900	864	475	175

Wardrobe Accessories

Leather Basket H-175mm

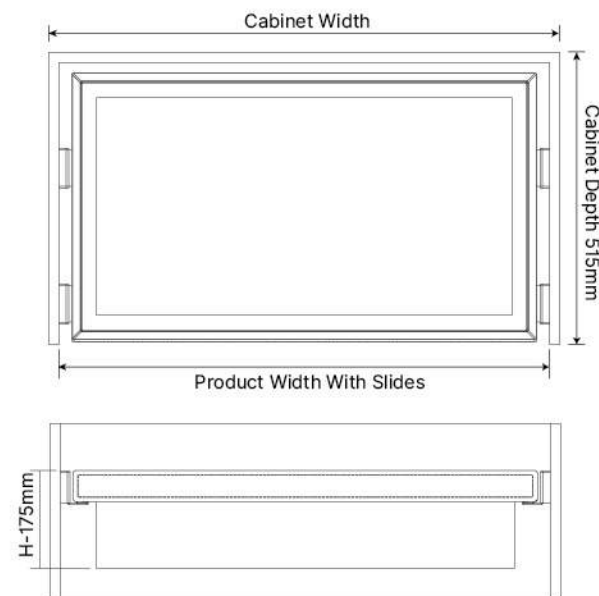

Specification

- › Rich & elegant combinations of luxurious leather & strong metal exudes a rich, timeless appeal.
- › Perfect for organizing a wide range of items from clothes, shirts, towels, accessories, purses & both small and large items.
- › Runners - Soft close drawer slides
- › Weight Capacity - Upto 30 Kgs.
- › Finish - Tan

Cabinet Width	Width (mm)	Depth (mm)	Height (mm)
600	564	425, 475	175
900	864	425, 475	175

Wardrobe Accessories

Wicker Basket

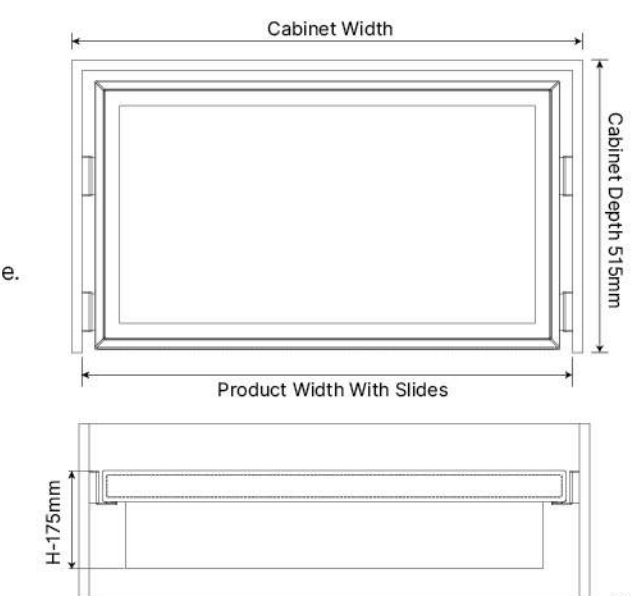

Specification

- › Aesthetic combination of natural wicker, sleek metal and rich leather that elevates your wardrobe storage adding an upscale look to your space.
- › Ample storage space for both small and large items.
- › Comes with a leather mat that is easily removable and can be wiped down ensuring your storage remains in pristine condition.
- › Runners - Soft close drawer slides
- › Weight Capacity - Upto 30 Kgs.
- › Finish - Tan & Mocha

Cabinet Width	Width (mm)	Depth (mm)	Height (mm)
600	564	475	175
900	864	475	175

Wardrobe Accessories

Trouser Rack

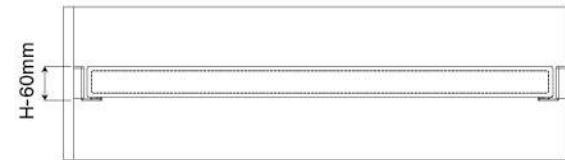
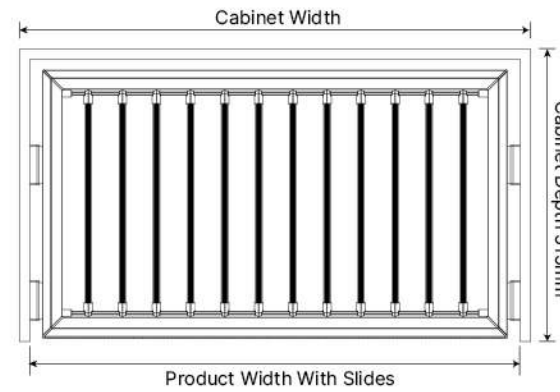

Specification

- › High quality metal frame with adjustable rods to accommodate various trouser lengths & sizes.
- › Organize trousers neatly saving space in your wardrobe & providing a clutter free storage solution. Simple design to slide trousers on & off.
- › It helps to store multiple trousers in organized manner.
- › Runners - Soft close drawer slides
- › Weight Capacity - Upto 30 Kgs.

Cabinet Width	Width (mm)	Depth (mm)	Height (mm)
600	564	425, 475	60
900	864	425, 475	60

Wardrobe Accessories

Laundry Basket

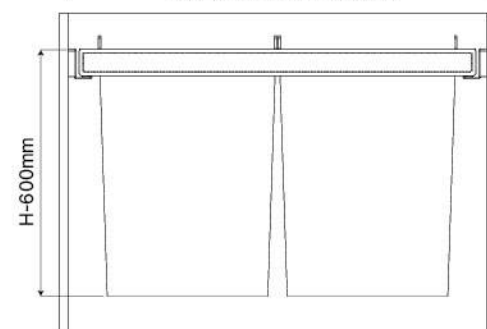
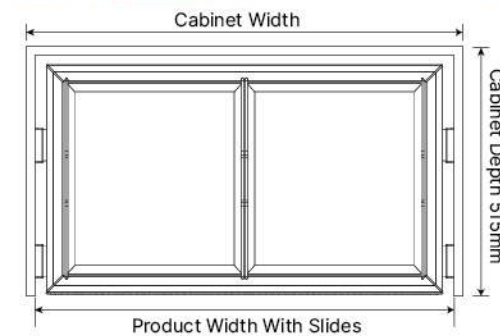

Specification

- › The laundry basket is housed in a modern frame, giving it an elegant and polished look that complements any wardrobe.
- › The innovative channel design allows the basket to slide in and out of the wardrobe effortlessly, maximizing storage space.
- › The removable bags are easy to clean.
- › Not just for laundry, it can also be used for storing toys, clothes and cushions.

Cabinet Width	Width (mm)	Depth (mm)	Height (mm)
600	564	475	600
900	864	475	600

Wardrobe Accessories

Shoe Rack

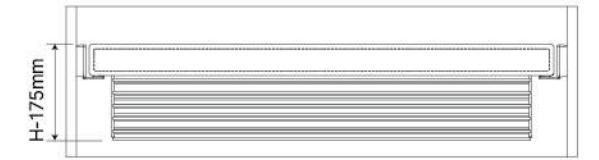
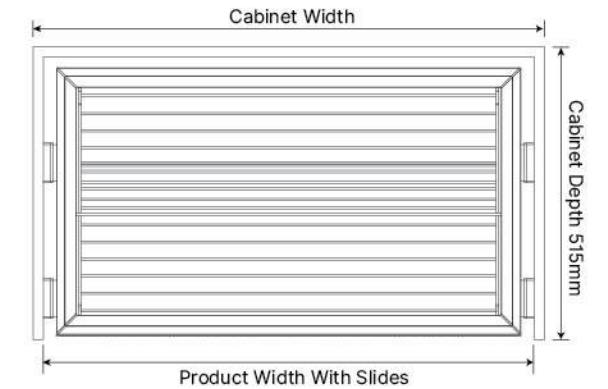
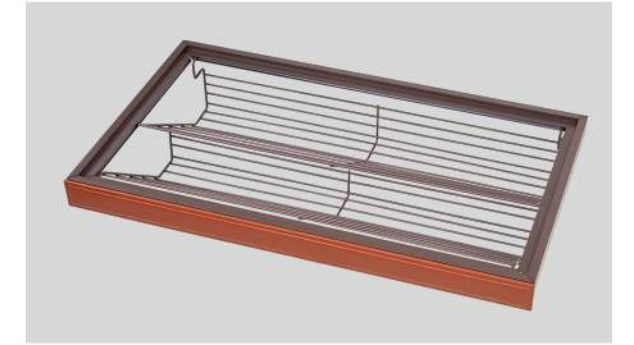

Specification

- › Designed to organize and store shoes, sandals and other footwear in an efficient and accessible manner.
- › Elegant metal rods that create a sturdy framework for holding shoes and sandals neatly.
- › Runners - Soft close Drawer slides
- › Weight Capacity - Upto 30 Kgs.
- › Finish - Tan + Mocha

Cabinet Width	Width (mm)	Depth (mm)	Height (mm)
600	564	475	175
900	864	475	175

Wardrobe Accessories

Multi Layer Rotating Shoe Rack



Specification

- › Designed to store shoes and sandals in an organized way, keeping them neatly arranged and easy to access.
- › Constructed with high quality metal ensuring the frame is strong enough to hold multiple pairs of shoes without warping or losing shape.
- › Features multiple tiers or vertical spaces allowing users to store shoes of various sizes and styles in an orderly fashion.
- › Weight Capacity - Upto 45 Kgs.
- › Finish - Tan + Mocha

Cabinet Width	Width (mm)	Depth (mm)	Height (mm)	Layer
600	500	360	1340	6
600	500	360	2180	12
900	800	360	1340	6
900	800	360	2180	12

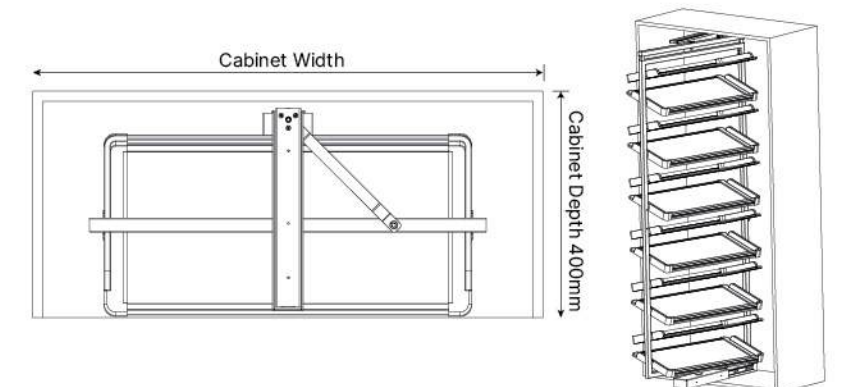

Wardrobe Accessories

Top Mounted Trouser Rack

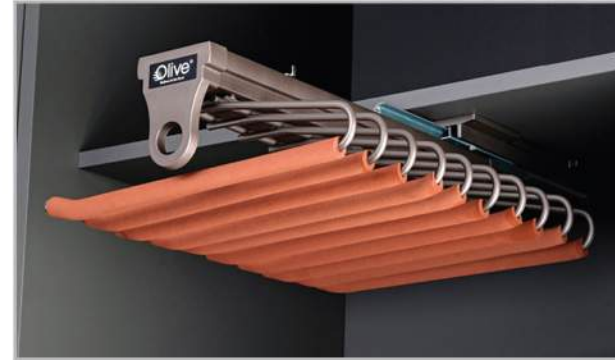

Specification

- › Mounted at the top of your wardrobe this rack provides easy access to your trousers and all other types of clothes without taking up wardrobe floor space.
- › The rack slides in and out with ease using a well designed channel offering convenient access to stored garments.
- › Equipped with soft foam covered rods that prevent wrinkles & fabric damage ensuring your trousers remains in best condition.
- › Soft close running slide
- › Weight Capacity - Upto 15 Kgs.
- › Finish - Tan & Mocha

Cabinet Width	Width (mm)	Depth (mm)	Height (mm)
Min. 400	340	465	157

Wardrobe Accessories

Side Sliding Trouser Rack



Specification

- › Equipped with a sliding mechanism that operates smoothly.
- › Helps organizing trousers neatly offering a clutter free solution.
- › Perfect for wardrobes with limited space as it utilizes side space to keep everything within an easy reach.
- › Soft close running slide
- › Weight Capacity - Upto 15 Kgs.
- › Finish - Tan & Mocha.

Cabinet Size	Width (mm)	Depth (mm)	Height (mm)
Min. 450	343	465	128

Wardrobe Accessories

Top Mounted Two Side Trouser Rack



Specification

- › Dual sided storage featuring two racks on either sides allowing you to store more trousers & clothing in a compact space.
- › Maximizing wardrobe spaces by utilizing the upper area for organized easy to access storage.
- › Built with durable materials this rack is designed to hold multiple garments securely, Offering a reliable storage solution.
- › Soft close running slide
- › Weight Capacity - Upto 15 Kgs.
- › Finish - Tan & Mocha

Cabinet Size	Width (mm)	Depth (mm)	Height (mm)
Min. 700	596	465	126

Wardrobe Accessories

Top Mounted Clothes Hanger

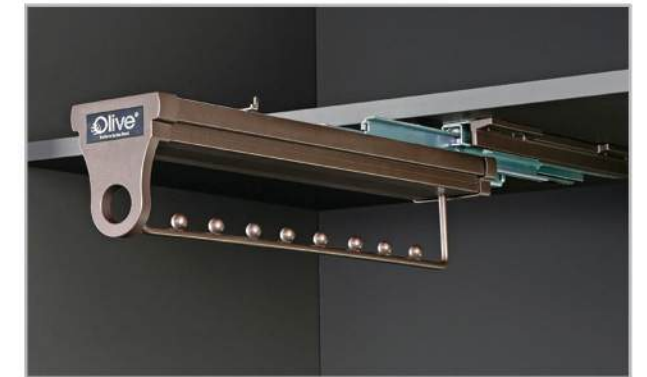

Specification

- › This hanger is mounted at the top of the wardrobe allowing an efficient use of overhead space to store clothing like shirts, coats, suits etc.
- › Slides easily in and out making it simple to store & retrieve garments without disruption.
- › Built to last this cloth hanger ensures a practical & long time solution for your wardrobe storage.
- › The discreet, top mounted design helps keep your wardrobe organized and clothes neatly hung without taking extra room.
- › Soft close running slide
- › Weight Capacity - Upto 15 Kgs.
- › Finish - Mocha

Cabinet Size	Width (mm)	Depth (mm)	Height (mm)
Min. 600	128	465	126

Wardrobe Accessories

Pull Down Cloth Hanger

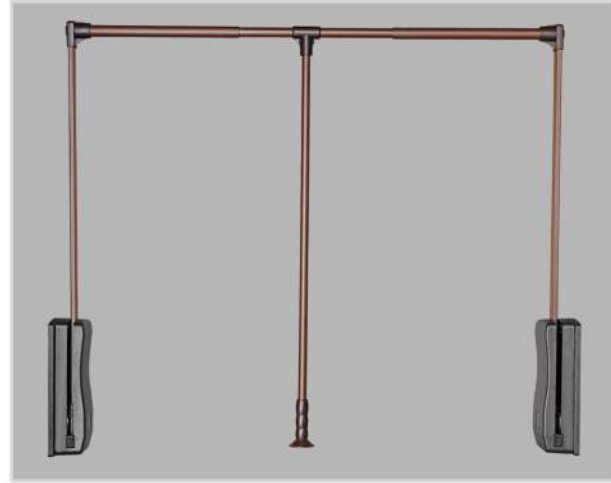

Specification

- › This pull-down hanger allows you to bring down hanging garments with ease, perfect for high shelves or top mounted spaces.
- › Effortlessly pulls down to provide immediate access to your stored garments.
- › Ideal for maximizing space especially for high closets, by offering easy to access hanging storage.
- › Built for longevity this hanger is designed to withstand frequent use offering reliable & practical storage.
- › Weight Capacity - Upto 15 Kgs.
- › Finish - Black & Mocha

Cabinet Size	Width (mm)	Depth (mm)	Height (mm)
Max. 1200	864-1240	355	830

Wardrobe Accessories

Pullout 2 Layer



Specification

- › The pullout system features a durable metal frame combined with baskets covered in a rich leather finish.
- › The sliding frame makes it easy to keep your belonging neatly stored and quickly accessible.
- › Perfect for organizing shoes, lotions, towels, purses, perfume and other essentials in a stylish and space efficient manner.
- › Soft close running slides
- › Weight Capacity - Upto 15 Kgs.
- › Finish - Tan & Mocha

Cabinet Size	Width (mm)	Depth (mm)	Height (mm)
Min. 400	350	450	610

Wardrobe Accessories

Sliding Tie Rack



Specification

- › This rack is specially designed for the neat storage of ties, scarves & belts.
- › The rack slides smoothly in and out allowing you to browse through your ties without disrupting the rest of your wardrobe.
- › A highly practical solution to keep your ties neatly hung and within easy reach, reducing clutter and saving space.
- › Soft close running slides
- › Weight Capacity - Upto 15 Kgs.
- › Finish - Mocha

Cabinet Size	Width (mm)	Depth (mm)	Height (mm)
Min. 150	120	465	80

Wardrobe Accessories

Pullout 3 Layer



Specification

- › The combination of a metal frame and leather touched baskets provides high end refined look that compliments any wardrobe design.
- › Comes with 3 layers, making it ideal for the storage of small items.
- › Adjustable frame for an easy shuffling of baskets as per storage need.
- › Soft close running slides
- › Weight Capacity - Upto 15 Kgs.
- › Finish - Tan & Mocha

Cabinet Size	Width (mm)	Depth (mm)	Height (mm)
Min. 400	350	450	780

Wardrobe Accessories

Watch Winder (Square)



Specification

- › Offers ample space to store four and six watches, keeping them safe, organised and always ready to use.
- › The Watch Winder has a built in mechanism that rotates your watches, ensuring they remain wound and accurate, even when not worn.
- › Features integrated lighting that adds a sophisticated touch.
- › The winder comes with a sensitive touch opening mechanism allowing you to easily access your watches with a simple touch.
- › Comes with sleek and elegant square design.
- › Finish - Mocha

Cabinet Size	Width (mm)	Depth (mm)	Height (mm)	Store upto
Min.600	564	425	225	4 Watches
Min.900	864	425	225	6 Watches

Wardrobe Accessories

Safe Box



Specification

- › A discreet yet secure drawer that functions as a safe, providing a hidden storage for valuables.
- › Equipped with a customizable number combination lock, ensuring only authorized access to your important items.
- › The front of the drawer features a luxurious leather finish, adding a touch of style & sophistication.
- › Perfect for storing cash, jewellery, important documents and other valuables that needs extra security.
- › Ideal for residential and office use.
- › Finish - Tan

Cabinet Size	Width (mm)	Depth (mm)	Height (mm)
Min. 500	464	425	155
Min. 600	564	425	155
Min. 900	864	425	155

Wardrobe Accessories

Watch Winder (Round)



Specification

- › Offers ample space to store four and six watches, keeping them safe, organised and always ready to use.
- › The Watch Winder has a built in mechanism that rotates your watches, ensuring they remain wound and accurate, even when not worn.
- › Features integrated lighting that adds a sophisticated touch.
- › The winder comes with a sensitive touch opening mechanism allowing you to easily access your watches with a simple touch.
- › Comes with sleek and elegant round design.
- › Finish - Mocha

Cabinet Size	Width (mm)	Depth (mm)	Height (mm)	Store upto
Min.600	564	425	225	4 Watches
Min.900	864	425	225	6 Watches

Wardrobe Accessories

Multipurpose Drawers Set



Specification

- › Features 3 generously sized drawers perfect for organizing accessories and other personal items.
- › Each drawer is finished with luxurious full leather look that compliments any wardrobe or room decor.
- › Ready to use right out of the box with no installation needed, making it hassle free.
- › The drawers comes with a simple pull mechanism allowing easy access without need for channels or complex hardware.
- › Finish - Tan

Cabinet Size	Width (mm)	Depth (mm)	Height (mm)
Min. 900	864	425	155

Wardrobe Accessories

Single Drawer



Specification

- › Features single sized drawers perfect for organizing accessories and other personal items.
- › Drawer finished with luxurious full leather look that compliments any wardrobe or room decor.
- › Ready to use right out of the box with no installation needed, making it hassle free.
- › The drawer comes with a simple pull mechanism allowing easy access without need for channels or complex hardware.
- › Finish - Tan

Cabinet Size	Width (mm)	Depth (mm)	Height (mm)
Min.500	400	425	155

Wardrobe Accessories

Leather Hanger Rod With Bracket



Specification

- › This hanging rod features a modern square design with a sleek leather finish.
- › Comes with two types of hooks, top mounted hooks are for a more minimalist look and side mounted hooks for added flexibility allowing you to choose the best installation style.
- › Ideal for hanging clothes it provides neat and organized way to store your essentials from shirts to coats to dresses.
- › Finish - Mocha

Cabinet Size	Width (mm)	Height (mm)	Length (mm)
-	22	78	3000

Wardrobe Accessories

Hangers



Hanger - 1



Hanger - 2



Hanger - 3



Hanger - 4





Specification

- › Crafted from high quality luxurious leather, these utility boxes bring both elegance and durability to your wardrobe or vanity.
- › Designed to fit seamlessly inside plain wardrobe baskets, these boxes provides efficient & organized storage for a range of personal items.
- › Choose the right box for your specific needs wheather its for jewellery, accessories, sunglasses, personal care items keeping everything neatly arrange & easily accessible.
- › Available in 7 different types
- › Finish - Tan

Width (mm)	Depth (mm)	Height (mm)
175	375	55



Multiutility Box 1



Multiutility Box 2



Multiutility Box 3



Multiutility Box 4



Multiutility Box 5



Multiutility Box 6



Multiutility Box 7



Wardrobe Accessories

Storage Boxes - Tan



Storage Box 1 Size : 280 x 450 x 150



Storage Box 2 Size : 280 x 450 x 250



Storage Box 3 Size : 420 x 450 x 150



Storage Box 4 Size : 420 x 450 x 250



Storage Tray 1 Size : 360 x 450 x 120



Storage Tray 2 Size : 280 x 450 x 100



Specification

- › These elegant leather storage boxes come in multiple sizes and heights, offering flexible storage options for a range of items.
- › These boxes can be easily stacked or placed inside wardrobes maximizing storage spaces without compromising on style.
- › Not just for wardrobe, these boxes are perfect for vanities, dressing tables or even as a stylish addition to any room for storing miscellaneous items.
- › Ideal for storing valuables, documents, accessories & other precious items ensuring they stay protected & organized.
- › Finish - Tan

Wardrobe Accessories

Revolving Mirror



Specification

- › This sleek revolving mirror is designed to slide out smoothly from a channel within your wardrobe.
- › The mirror rotates fully, allowing you to adjust it to the perfect angle for a clear all around view.
- › When not in use simply slide it back into your wardrobe.
- › Perfect for creating a compact organized dressing area inside your wardrobe making it easier to check your outfits and appearance without the need of additional floor space.
- › 3450 rotating angle
- › Frame finish - Mocha

Cabinet Size	Width (mm)	Depth (mm)	Height (mm)
350	60	350	1000

Wardrobe Accessories

Garnishry Box



Code - OWA-11

Cabinet Size	Width (mm)	Depth (mm)	Height (mm)
600	564	475	85
900	864	475	85

Wardrobe Accessories

Trouser & Clothes Rack



Code - OWA-13

Cabinet Size	Width (mm)	Depth (mm)	Height (mm)
600	564	475	95
900	864	475	95

Wardrobe Accessories

Trouser Rack



Code - OWA-17

Cabinet Size	Width (mm)	Depth (mm)	Height (mm)
600	564	475	72
900	864	475	72

Wardrobe Accessories

Clothes Rack (PVC)



Code - OWA-16

Cabinet Size	Width (mm)	Depth (mm)	Height (mm)
600	564	475	95
900	864	475	95

Wardrobe Accessories

Clothes Rack (SS)



Code - OWA-14

Cabinet Size	Width (mm)	Depth (mm)	Height (mm)
600	564	475	160
900	864	475	160

Wardrobe Accessories

Up & Down Rack (With Soft-Close)



Code - OWA-02

Cabinet Size	Width (mm)	Depth (mm)	Height (mm)
Max. 1200	864-1240	355	830

Wardrobe Accessories

Clothes Basket



Code - OWA-12

Cabinet Size	Width (mm)	Depth (mm)	Height (mm)
600	564	475	200
900	864	475	200

Wardrobe Accessories

Shoe Rack (Adjustable)



Code - OWA-12

Cabinet Size	Width (mm)	Depth (mm)	Height (mm)	Layers
600	500	360	1340	6
900	800	360	2180	12
600	500	360	1340	6
900	800	360	2180	12

Shoe Rack Installation Video





11 Hook Trouser Rack

- Size - W- 365mm D-480mm H- 120mm
- Removal both left & right
- Elegant and modern design



Wardrobe Basket SS Strip

- Size: W-710, 810, 910mm x D-508mm x H-150, 200mm
- Finish - Chrome



Wardrobe Basket SS Wire

- Size: W-710, 810, 910mm x D-508mm x H-150, 200mm
- Finish - Chrome



Sliding Hanger Holder

- Size: W-35mm x D-508mm x H-150mm
- Wrinkle free and easily accessible
- Provide ample space to hang your clothes



Trouser Slider - Regular

- Size: W-370mm x D-508mm x H-175mm
- Side mounted sliding system



Trouser Slider - Sleek

- Size: W-370mm x D-508mm x H-175mm
- Finish - Chrome



Tie Slider - Regular

- Size: W-150mm x D-508mm x H-60mm
- Stainless steel material
- Easy access to take ties



Trouser Rack

- Size: W-710, 810mm x D-508mm x H-60mm
- Durable quality



Iron Rack

- Size: W-265mm x D-435mm x H-145mm
- Easy to installation
- Space saving & convenient to use



Perfume Rack - Wooden Base

- Size: W-300, 405mm x D-100mm x H-100mm
- Wooden base ideal rack to store perfumes



Perfume Rack - Wire Base

- Size: W-300 & 405mm D-100mm H- 100mm
- Wire base
- Perfect storage shelf



Hook Liner - Sleek

- 4 hook w-260mm
- 6 hook w-380mm
- 8 hook w-475mm

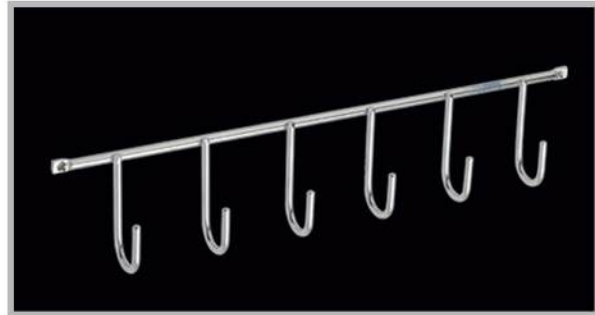

Hook Liner - Regular

- 4 hook w-260mm
- 6 hook w-380mm
- 8 hook w-475mm

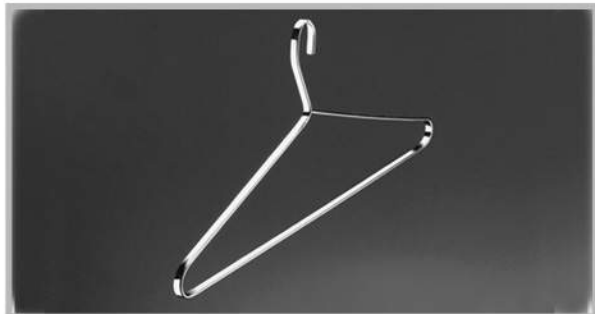

Cloth Hanger

- Designed to hanging suits.
- Stainless steel material

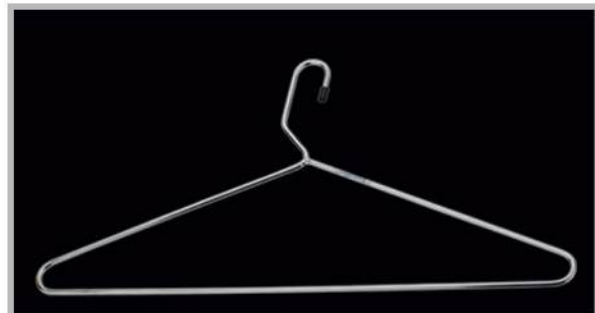

Cloth Hanger Wire

- Designed to hanging suits.
- Stainless steel material



Oval Pipe & Pipe Holder

- Size: W-35mm D-150mm H- 900 & 1200m
- Hanging rods use in wardrobe.
- Stainless steel material.



WSF - 01

Product Specification:

- Easy installation.
- Apply to wooden furniture, poly-wood furniture.
- Loading capacity of door: 25 kg.

WSP-02 Sliding Top Profile

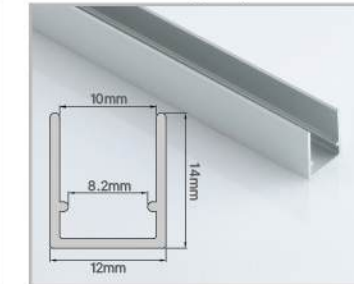

WSP-21 Sliding Bottom Profile

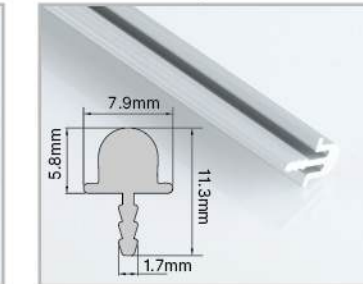

WSF - 02 Sliding Rollar 4 Wheel

Product Specification:

- Easy installation.
- Apply to wooden furniture, poly-wood furniture.
- Loading capacity of door: 25 kg.

WSP-03 Sliding Top & Bottom Profile





WSF - 03

Product Specification:

- Easy installation.
- Apply to wooden furniture, poly-wood furniture.
- Loading capacity of door: 40 kg.

WSF-03 Soft Close



WSP-01 Sliding Top Profile

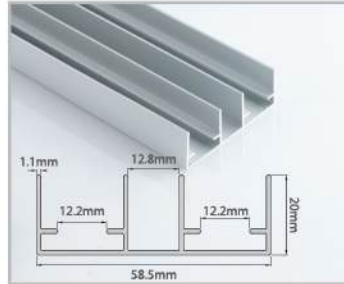

WSP-11 Sliding Bottom Profile

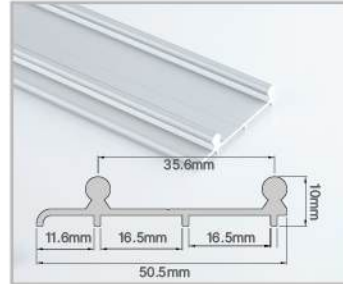

WSF - 04 For 2 Door & 3 Door

Product Specification:

- Original design with concealed damper in top panel 18mm.
- Automatic position pre-setting & easy installation of dampers.
- Single side soft closing system or 2 sides soft closing for optional.
- Loading capacity of door: 50 kg.

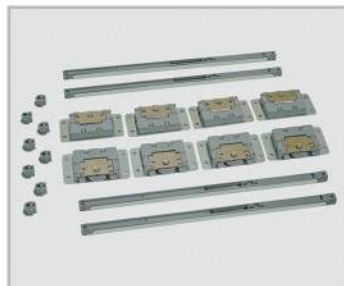

WSP-12 Sliding Top Profile

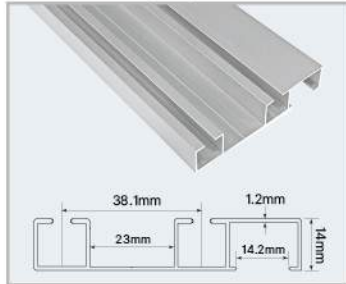

WSP-12 Sliding Bottom Profile

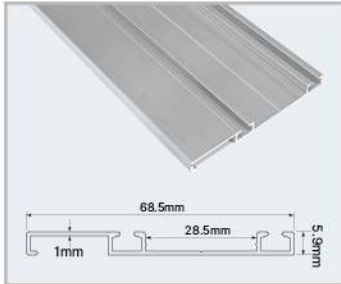

WSP-06 Sliding Top & Bottom Profile WSP-12C Bottom Cover Profile

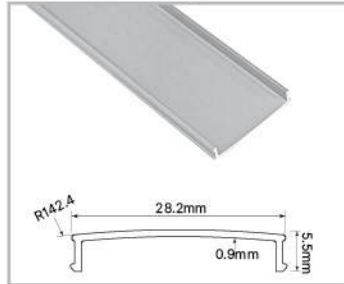

WSF - 06 & 07 For 2 Door & 3 Door

Product Specification:

- Imported POM material for wheel, to achieve best silent performance and long lifespan.
- Apply to door thickness for WSF-06 : 20mm
- Apply to door thickness for WSF-07 : 25mm
- Loading capacity of door: 60 kg.

WSF - 06 (20mm) For 2 Door & 3 Door WSP - 07 (25mm) For 2 Door & 3 Door



WSP-09 Sliding Top Profile

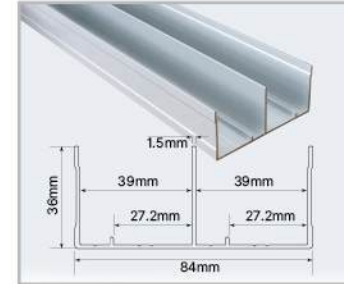

WSP-09 Sliding Bottom Profile



WSP-10 Sliding Top Profile

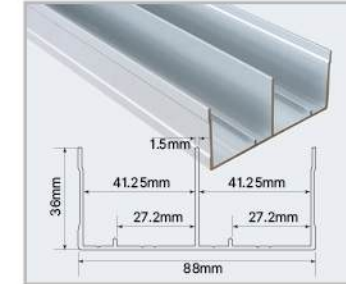

WSP-10 Sliding Bottom Profile

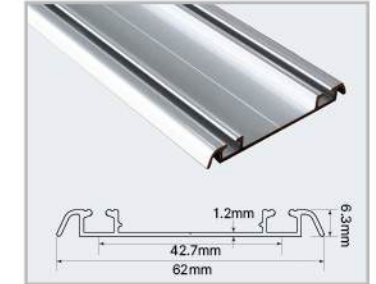

WSF - 08 For 2 Door & 3 Door

Product Specification:

- Apply to door thickness for : 20mm
- Loading capacity of door: 50 kg.
- Apply to heavy panel wood, solid wood and aluminum frame door.



WSP-12 Sliding Top Profile

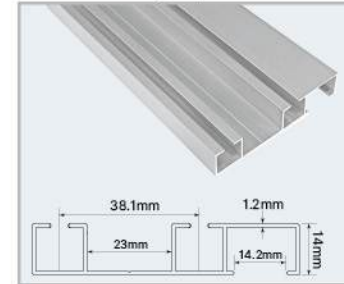

WSP-12 Sliding Bottom Profile



WSP-12C Bottom Cover Profile

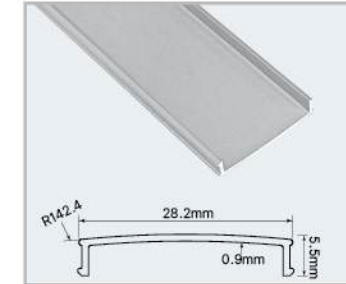



DSF - 01 Sliding Roller 4 Wheel

Product Specification:

- DSF-01 - Loading capacity of door: 40 kg.
- DSF-02 - Loading capacity of door: 50 kg.

DSF - 02 Sliding Roller 8 Wheel

WSP-04 4 Wheel & 8 Wheel Sliding Profile

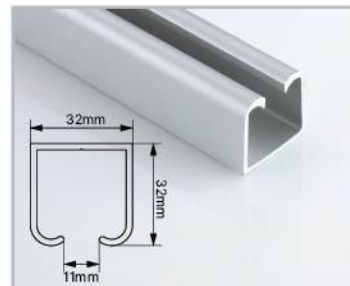

Single Door Lift-Up System

PRODUCT DESCRIPTION:-

Model	LF	Cabinet Height	Max. Weight
SINGLE-L	1600-2100	Up to 450mm	4.5 KG
SINGLE-H	3500-5800	Up to 600mm	10 KG

Cabinet Height [MM] x Door Weight [KG] = Load Factor [LF]

SPECIFICATIONS:-

- Maximum shutter opening angle 105°
- Suitable for cabinet width 600-900mm
- Suitable for cabinet heights between 205-600mm
- Minimum cabinet depth: ≥ 280mm
- Closing speed and damping force is adjustable
- Both panels allow 3D adjustment for precise alignment.
- Door panel thickness range: 16-25 mm



Bi-Fold Door Lift-Up System

PRODUCT DESCRIPTION:-

Model	LF	Cabinet Height	Max. Weight
BI-FOLD-MD	4900-6800	700mm - 900mm	9.7 KG
BI-FOLD-M	6500-8500	700mm - 900mm	12.1 KG
BI-FOLD-H	8400-12000	700mm - 900mm	17 KG

Cabinet Height [MM] x Door Weight [KG] = Load Factor [LF]

SPECIFICATIONS:-

- Opening angle adjustment 85° - 100°
- Suitable for cabinet widths 600-900mm
- Suitable for cabinet heights between 700-900mm
- Minimum cabinet depth: ≥ 280mm
- Closing speed and damping force is adjustable
- Both panels allow 3D adjustment for precise alignment.
- Door panel thickness range: 16-25mm





Elevator Basket - Glass

- Best solution for overhead cabinets.
- Ideally used for the kitchen overhead cabinet.
- The damping device is durable and can be pulled down or pushed back smoothly.

Cabinet Size	Width (mm)	Depth (mm)	Height (mm)
600	560-564mm	280 to 295Min	560Min
900	860-864mm		



GTPT (New)

- GTPT tray made with SS 304 material.
- Easy access of Glass & Plate in systematic arrangement.

Cabinet Size	Width (mm)	Depth (mm)	Height (mm)
500	465	245	80
600	565	245	80
700	665	245	80
800	765	245	80
900	865	245	80



Drip Tray (New)

- Drip tray use in GTPT for dripping water.
- Premium quality virgin ABS material

Cabinet Size	Width (mm)	Depth (mm)	Height (mm)
500	448	245	20
600	548	245	20
700	648	245	20
800	748	245	20
900	848	245	20



Cutlery Tray

- Finish : Silver Grey.
- Standard Height : 50mm

Cutlery Tray	Width Max	Width Min	Depth Max	Depth Min
NCT-335B	335	265	485	415
NCT-450B	385	315	485	415
NCT-500B	430	360	485	415
NCT-600B	530	460	485	415
NCT-700B	630	560	485	415
NCT-800B	730	660	485	415
NCT-900B	830	760	485	415



Dust Bin (PVC)

- DSH-PVC 10 Litre Capacity
- Size: W-270mm x H-335mm
- This bin have automatic opening for lids.
- Waste Management: Use PVC dust bins for disposing of household, office, industrial waste etc.
- Easy to clean & wash by hand.



Dust Bin (S.S.)

- DSH-SS 8 & 10 Litre Capacity
- Size: W-270mm x H-335mm
- This bin have automatic opening for lids.
- Waste Management: Use SS dust bins for disposing of household, office, industrial waste etc.
- Easy to clean & wash by hand.



Dust Bin - A

- Capacity 20 Litre.
- Size: W-235mm x D-305mm x H-375mm
- Easily put in office, kitchen etc.
- Easy to clean & wash by hand.



Dust Bin - B

- Capacity 10 Litre.
- Size: Dia. 250mm x H-290mm
- Easily put in office, kitchen etc.
- Easy to clean & wash by hand.



Waste Bin - 1 (With Soft Close)

- DB-20A 40 Litre Capacity
- Size: W-340mm x D-510mm x H-430mm
- Full extension slides provided for easy access of the buckets.



Waste Bin - 2A (With Soft Close)

- 2 Bin 20+20 Litre Capacity
- Size: W-362mm x D-510mm x H-400mm

20L 20L



Waste Bin - 4A (With Soft Close)

- 1 Bin 20 Litre Capacity
- Size: W-292mm x D-367mm x H-400mm

10L 10L



Waste Bin - 5A (With Soft Close)

- 2 Bin 20+10 Litre Capacity
- Size: W-292mm x D-510mm x H-400mm

20L



Waste Bin - 5B (With Soft Close)

- 2 Bin 10+10 Litre Capacity
- Size: W-292mm x D-367mm x H-400mm

10L 10L



Waste Bin - 6 (Revolving)

- 2 Bin 10+10 Litre Capacity
- Size: W-270mm x H-335mm



Anti Skid Mat

- W-500mm & 550mm x L-5000mm & 20,000mm
- Anti slip and easy to clean.
- Prevent from water & moisture
- Diamond cut design



Plate Holder

- Adjustable in width according to the size of the plates.
- Easy to Clean & Handle.
- Attractive design, Steel & PVC combination.
- Finish : Grey



Assembled Size :
 Min. Inner Width: 194mm (264mm outer width)
 Max. width: 341mm (411mm outer width)
 Total Height: 171mm (145mm height for place Plates)





Gold Telescopic Channel (Zinc)

- Available Size in inches: 10", 12", 14", 16", 18", 20", 22", 24", 30" & 36".
- Full extension drawer slides
- 48 Hours salt spray tested
- 3 Years Gaurantee
- Premium quality channel
- Loading capacity up to 45kg. (450mm Long)
- Finish : Zinc



Gold Telescopic Channel (Black)

- Available Size in inches: 10", 12", 14", 16", 18", 20", 22", 24", 30" & 36".
- Full extension drawer slides
- 48 Hours salt spray tested
- 3 Years Gaurantee
- Premium quality channel
- Loading capacity up to 45kg. (450mm Long)
- Finish : Black



Soft Close Telescopic Channel

- Available Size in inches: 12", 14", 16", 18", 20", 22" & 24".
- Full extension drawer slides
- 48 Hours salt spray tested
- Soft closing telescopic channel
- Loading capacity up to 45kg. (450mm Long)
- Finish : Zinc



S.S. Telescopic Channel

- Available Size in inches: 12", 14", 16", 18", 20" & 22".
- Full extension drawer slides
- 48 Hours salt spray tested
- Full stainless steel channel
- Loading capacity up to 45kg. (450mm Long)
- Finish : Zinc



Pepino Telescopic Channel (Zinc)

- Available Size in inches: 10", 12", 14", 16", 18", 20", 22" & 24".
- Full extension drawer slides
- 48 Hours salt spray tested
- Premium quality channel
- Loading capacity up to 35kg.
- Finish : Zinc



Pepino Telescopic Channel (Black)

- Available Size in inches: 10", 12", 14", 16", 18", 20", 22" & 24".
- Full extension drawer slides
- 48 Hours salt spray tested
- Premium quality channel
- Loading capacity up to 35kg.
- Finish : Black



Drawer Slide (Soft Close) For Prime Basket

- Available Size in inches: 12", 14", 16", 18", 20", 22" & 24".
- Soft close drawer slides
- Premium quality slide prime basket.
- Loading capacity up to 35kg.



Drawer Slide (40Kg)

- Available Size in inches: 12", 14", 16", 18", 20", 22" & 24".
- Soft close drawer slides
- Premium quality drawer slide
- Loading capacity up to 40kg.



Drawer Slide Detachable Strip

- Available Size in inches: 16", 18", 20", 22" & 24".
- Suitable for drawer slide 40Kg.



Locking Clip For Drawer Slide

- Quick Easy fit system
- Fit in drawer slide



Gas Spring - 9" (Lift Up)

- Soft & silent, self closing system.
- Loading capacity :- 5 kg, 10 kg, 15 kg, 20 kg, 25 kg.
- Gas spring provide a safe and controlled movement.



Gas Spring - 12" (Lift Up)

- Soft & silent, self closing system.
- Loading capacity:- 5 kg, 10 kg, 15 kg, 20 kg, 25 kg, 30 kg & 35 kg.
- Gas spring provide a safe and controlled movement.



Soft Close Gas Spring - 9" (Lift Up)

- Soft & Silent, self closing system.
- Loading capacity :- 5 kg, 10 kg, 15 kg, 20 kg, 25 kg.
- Gas spring provide a safe and controlled movement.



Bed Fitting (Heavy)

- Finish:- Black Powder Coated.
- Size: 3 Feet, 4 Feet & 5 Feet
- Best choice for bed fitting.



Gas Spring For Bed Fitting

- Soft & Silent opening system.
- Finish :- Black Powder Coated.
- Loading capacity :- 50kg, 75kg, 100kg, 125kg, 150kg, 175kg & 200kg.

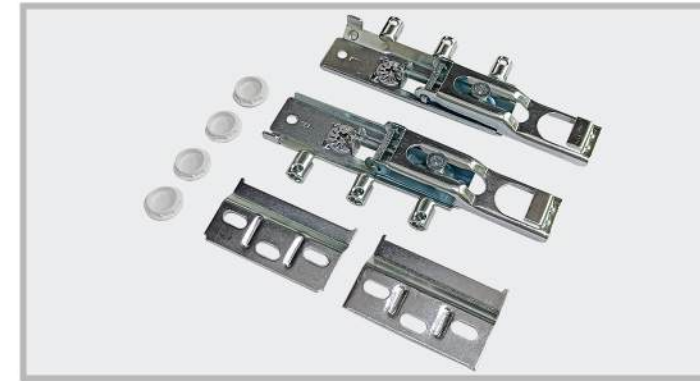

Concealed Hanging Bracket For Wall Cabinet

- Weight Capacity 60Kg.
- Finish - SS
- Hanging brackets use for hanging overhead cabinet.

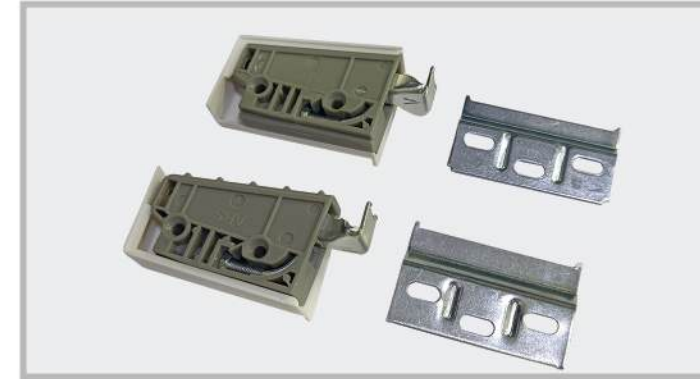

Hanging Bracket For Wall Cabinet

- Weight Capacity 60Kg.
- Finish - SS & White
- Durable and sturdy



Push To Open Damper (Regular)

- Use for doors without handle
- Finish - Black



Push To Open Damper (Recessed)

- Use for doors without handle
- Finish - Grey



Shelf Bracket

- Shelf bracket used in kitchen, wardrobe & bathroom
- Finish - S.S.
- Hidden shelf brackets can provide a clean and minimalist appearance



Cabinet Carcass Leg (Triangle-01)

- Available in 100mm & 150mm height.
- Better stability with triangular base.
- Finish - Black
- Cabinets carcass legs are used in kitchen, offices, bathroom & wardobes



Cabinet Carcass Leg (Round-01)

- Available in 100mm & 150mm height.
- Quick fit system
- Finish - Black
- Cabinets carcass legs are used in kitchen, offices, bathroom & wardobes



Skirting Clip

- Suitable for carcass leg
- Easy to fit in leg
- Finish: Black



Cabinet Carcass Leg (Triangle-02)

- Available in 75mm, 100mm & 150mm height.
- Better stability with triangular base.
- Finish: Black



Cabinet Carcass Leg (Round-02)

- Available in 75mm, 100mm & 150mm height.
- Quick fit system
- Finish: Black



Skirting - Black

- Available in H-100mm x Length - 4 Mtr.
- Finish: Black
- Skirting add a decorative touch to kitchen.
- Skirting can be easily removed & replaced



Skirting - Silver

- Available in H-100mm x Length - 4 Mtr.
- Finish: Silver
- Skirting add a decorative touch to rooms.
- Skirting can be easily removed & replaced.

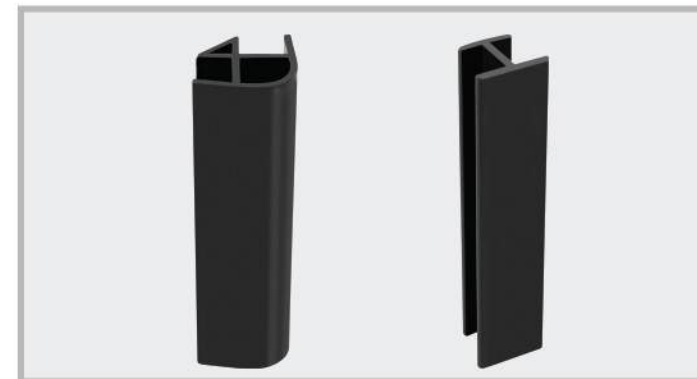

Skirting Corner & Connector - Black

- Size - H-100mm x 90° Corner
- Size - H-100mm x 180° Corner
- Finish: Black.
- Used to connect two skirting boards together at a 90° angle.

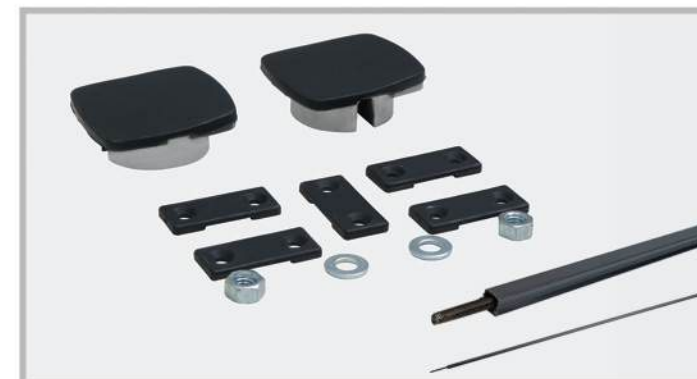

Door Stiffener

- Door Stiffener Length 1900mm.
- Best use for cabinet door.
- Increased Durability.

“Hardware That Builds Trust”



SS 201 Soft Close Clip on Hinges 2D

- Opening angle 110°
- Shallow cup depth 13mm, also suitable for soft-formed doors
- 3-dimensional adjustment with suitable mounting plate
- Shallow cup diameter 25mm
- Available in Two Types
 - a) Regular Hinges b) Soft Close Hinges
- Available with full overly, Half Overly & Insert



Black Soft Close Clip on Hinges 3D

- Opening angle 110°
- Shallow cup depth 13mm, also suitable for soft-formed doors
- 3-dimensional adjustment with suitable mounting plate
- Shallow cup diameter 25mm
- Available in Two Types
 - a) Soft Close Hinges b) Soft Close Clip-On Hinges
- Available with full overly & Half Overly



Zinc Soft Close Clip on Hinges 3D

- Opening angle 110°
- Shallow cup depth 13mm, also suitable for soft-formed doors
- 3-dimensional adjustment with suitable mounting plate
- Shallow cup diameter 25mm
- Available in Two Types
 - a) Soft Close Hinges b) Soft Close Clip-On Hinges
- Available with full overly & Half Overly



Regular Hinges

- Opening angle 110°
- Shallow cup depth 13mm, also suitable for soft-formed doors
- 3-dimensional adjustment with suitable mounting plate
- Shallow cup diameter 35mm
- Available in Two Types
 - a) Regular Hinges b) Clip-On Hinges
- Available with full overly, Half Overly & Insert



Soft Close Hinges

- Opening angle 110°
- Shallow cup depth 13mm, also suitable for soft-formed doors
- 3-dimensional adjustment with suitable mounting plate
- Shallow cup diameter 35mm
- Available in Two Types
 - a) Soft Close Hinges b) Clip-On Hinges
- Available with full overly, Half Overly & Insert



30° Regular Hinges

- Opening angle 30°
- Shallow cup depth 13mm
- 3-dimensional adjustment with suitable mounting plate
- Shallow cup diameter 35mm



45° Regular Hinges

- Opening angle 45°
- Shallow cup depth 13mm
- 3-dimensional adjustment with suitable mounting plate
- Shallow cup diameter 35mm



90° Regular Hinges

- Opening angle 90°
- Shallow cup depth 13mm
- 3-dimensional adjustment with suitable mounting plate
- Shallow cup diameter 35mm
- Available in Two Types
 - a) Regular Hinges b) Soft Close Clip-On Hinges



135° Regular Hinges

- Opening angle 135°
- Shallow cup depth 13mm
- 3-dimensional adjustment with suitable mounting plate
- Shallow cup diameter 35mm



165° Regular Hinges

- Opening angle 165°
- Shallow cup depth 13mm
- 3-dimensional adjustment with suitable mounting plate
- Shallow cup diameter 35mm
- Available in Two Types
 - a) Regular Hinges b) Soft Close Clip-On Hinges



Profile Soft-Close Clip On Hinge (P2)

- Opening angle 110°
- 3-dimensional adjustment with suitable mounting plate
- Available in Two Types
- Available with full overly & Half Overly

Kitchen Accessories & Furniture Hardware Fittings

DO'S



Hardware installation to be carried out only after civil & painting work is completed.

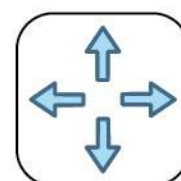

Ensure proper adjustments /alignments and after installation (including floor level and cabinet dimension).



Install the products as per fitting instructions provided



Always use a clean and dry cloth to wipe any part of the hardware. May be done twice a month.



For materials such as stainless steel etc. Always use a special cleaner (if available) or clean water in a soft cloth or sponge (slightly damp, not wet) and re-wipe the area with a dry cloth once done



If unsure about product installation, please download fitting instruction from www.oliveworld.co.in or contact our authorized distributor/dealer or company directly for assistance.

DON'TS



Do not lubricate the products without first checking the applicability of the lubricant with the company.



Do not abuse the product- i.e., hammering and forcefully exceeding the opening angles, forcefully pushing the channels without considering / checking for side gaps, exceeding the specified load capacity exposing to heat or fire etc. (Do not alter or modify a product)



Do not use any kind of cleaning agents such as Thinner, Turpentine Oil, Colin, Detergent Solutions etc. to clean hardware components. Do not apply Paints, Polish, Varnish.



Do not let saw dust and concrete rubble / dust enter any components of the hardware



Do not open a product to inspect its internal parts without consulting an authorized distributor or the company directly.